

devinci

DEVINCI BICYCLES
OWNER'S MANUAL
VERSION 3.2

This manual meets EN Standards 14764, 14565, 14566, 14781.

This manual meets ISO 4210:2014 standards,





IMPORTANT WARNING

Most sports carry the risk of injury, damage or both, and bicycling is no exception. By choosing to ride a bike, you are aware of these inherent dangers and risks. You also agree to take full responsibility for those risks. Neither the manufacturer, nor the distributor, nor the person who sold your bike, nor the people that do the maintenance of the trails where you ride can be held responsible. Since you take full responsibility, it is imperative that you read and fully understand the content of this manual.

It is your duty to do the proper maintenance on your bicycle and, therefore, substantially reduce the risk of injury.

Riding a bicycle can be a very dangerous activity, even under the best circumstances. Also, since it is impossible to predict all the situations you may face, this manual is not meant to describe every aspect of safe use. Many risks inherent to riding a bike cannot be predicted or avoided and they are, therefore, your sole responsibility.

This manual uses **WARNING** and **CAUTION** tabs that warn you about consequences that might occur because of bad inspection or inadequate maintenance of your bicycle. Also, not respecting traffic laws can lead to serious injury or damage. The symbol  and the word **WARNING** always indicate risk of serious injury that could even lead to death. The symbol  and the word **CAUTION** imply the possibility of serious damage to your bicycle and the risk of voiding your warranty.



YOUR AUTHORIZED DEVINCI DEALER

Your authorized Devinci dealer is committed to guiding you in the process of choosing a bike with accessories that really are adapted to the type of cycling you wish to practice. It also provides help concerning maintenance, so you can fully benefit from your investment. Authorized Devinci staff possess the knowledge, the experience and the necessary tools to adequately repair and provide reliable advice.

However, your dealer cannot make decisions on your behalf and be held responsible for your lack of knowledge, experience, qualifications or common sense. On the other hand, your authorized Devinci dealer can take the time to explain how your bike and its components work or what accessories will meet your specific needs.

If you have a problem or need information, consult your authorized Devinci dealer immediately, who will be glad to answer and guide you.

For a paper version of this document, please contact : service@devinci.com or 418 549-6218

PLEASE MAKE SURE TO REGISTER YOUR BIKE AT

<http://www.devinci.com/registration/>

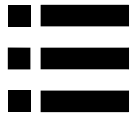

TABLE OF CONTENTS

IMPORTANT WARNING	2		
YOUR AUTHORIZED DEVINCI DEALER	2		
TABLE OF CONTENTS	3		
NOMENCLATURE OF YOUR BIKE	5		
THE BICYCLE USE	8		
4.1 <i>Maximum luggage weight</i>	10		
FUNDAMENTALS OF CYCLING	10		
5.1 Getting started	10		
5.1.1 <i>Bike Dimensions</i>	10		
5.1.2 <i>Security and Bicycling</i>	11		
5.2 Tuning your bike according to your morphology	11		
5.2.1 <i>Dimensionst</i>	12		
5.2.2 <i>Saddle positioning</i>	12		
5.2.3 <i>Handlebar positioning</i>	14		
5.2.4 <i>Brake levers and shifters position</i>	15		
5.2.5 <i>Brake tuning</i>	15		
5.3 Safety equipment	15		
5.3.1 <i>Helmet</i>	15		
5.3.2 <i>Reflectors</i>	16		
5.3.3 <i>Lights</i>	16		
5.3.4 <i>Pedals</i>	16		
5.3.5 <i>Eyewear</i>	16		
5.4 Mechanical safety inspection	17		
5.4.1 <i>Nuts, bolts and clamps</i>	17		
5.4.2 <i>Tire and wheels</i>	17		
5.4.3 <i>Brakes</i>	17		
5.4.4 <i>Wheel and seat post quick releases</i>	17		
5.4.5 <i>Handlebar and saddle alignment</i>	17		
5.4.6 <i>Handlebar extremities</i>	17		
FOR A SAFE AND SMART EXPERIENCE	18		
6.1 Fundamentals of cycling	18		
6.2 Road bike Safety Code	18		
6.3 Off-road bike Safety Code	20		
6.4 Riding at night	20		
6.5 Riding on wet surfaces	21		
6.6 Extreme and competitive use	21		
TECHNICAL INFORMATION	21		
7.1 Wheels	22		
		7.1.1 <i>Assembly and disassembly</i>	22
		7.1.3 <i>Risks of tightening whitout a wheel inserted</i>	26
		7.2 Seatpost	26
		7.3 Brakes	26
		7.3.1 <i>Brake functioning</i>	27
		7.3.2 <i>Brake tuning</i>	28
		7.4 Drivetrain	28
		7.4.1 <i>Drive train functioning</i>	29
		7.5 Tires and inner tubes	30
		7.5.1 <i>Tires</i>	31
		7.5.2 <i>Valves</i>	32
		7.6 Toe-clips	32
		7.7 Clipless pedals	32
		7.8 Suspension	33
		7.9 Component upgrades	33
		7.9.1 <i>Comfort improvement</i>	33
		7.9.2 <i>Achieving higher performance by upgrading</i>	34
		CARBON AND ALUMINIUM	35
		8.1 Properties of Metals	35
		8.2 The Basics of Metal Fatigue	35
		8.3 Understanding Composites	36
		8.3.1 <i>Composites</i>	36
		8.4 The limits of Composites	36
		8.5 Inspection of Composite Frame, Fork, and Components	37
		MAINTENANCE AND REPAIR	38
		9.1 Maintenance Schedule	38
		9.1.1 <i>Breaking-in period</i>	38
		9.1.2 <i>Before every use</i>	38
		9.1.3 <i>After every long or intense ride</i>	38
		9.1.4 <i>After every long or intense ride or after 10 to 20 hours of use</i>	38
		9.1.5 <i>Braking and shifting issues</i>	39
		9.1.6 <i>After riding 25 off-road hours or 50 road hours</i>	39
		9.2 Emergency repair	39
		9.2.1 <i>Flat tire</i>	40
		9.2.2 <i>Broken spoke</i>	40

9.2.3 Accident or major impact..... 41

MATERIAL KNOWLEDGE, ALUMINIUM AND CARBON.....41

10.1 Inspection41

10.1.1 Visual..... 42

10.1.2 Touch..... 42

10.2 Maintenance.....42

STORAGE YOUR BICYCLE PROPERLY.....42

11.1 Proper Use42

11.1.1 Bicycle racks..... 42

11.1.3 Bicycle travel case..... 43

11.1.3 Storage..... 43

11.2 Frame replacement policy.....43

WARRANTY PERIOD FROM DEVINCI CYCLES INC.....44



NOMENCLATURE OF YOUR BIKE

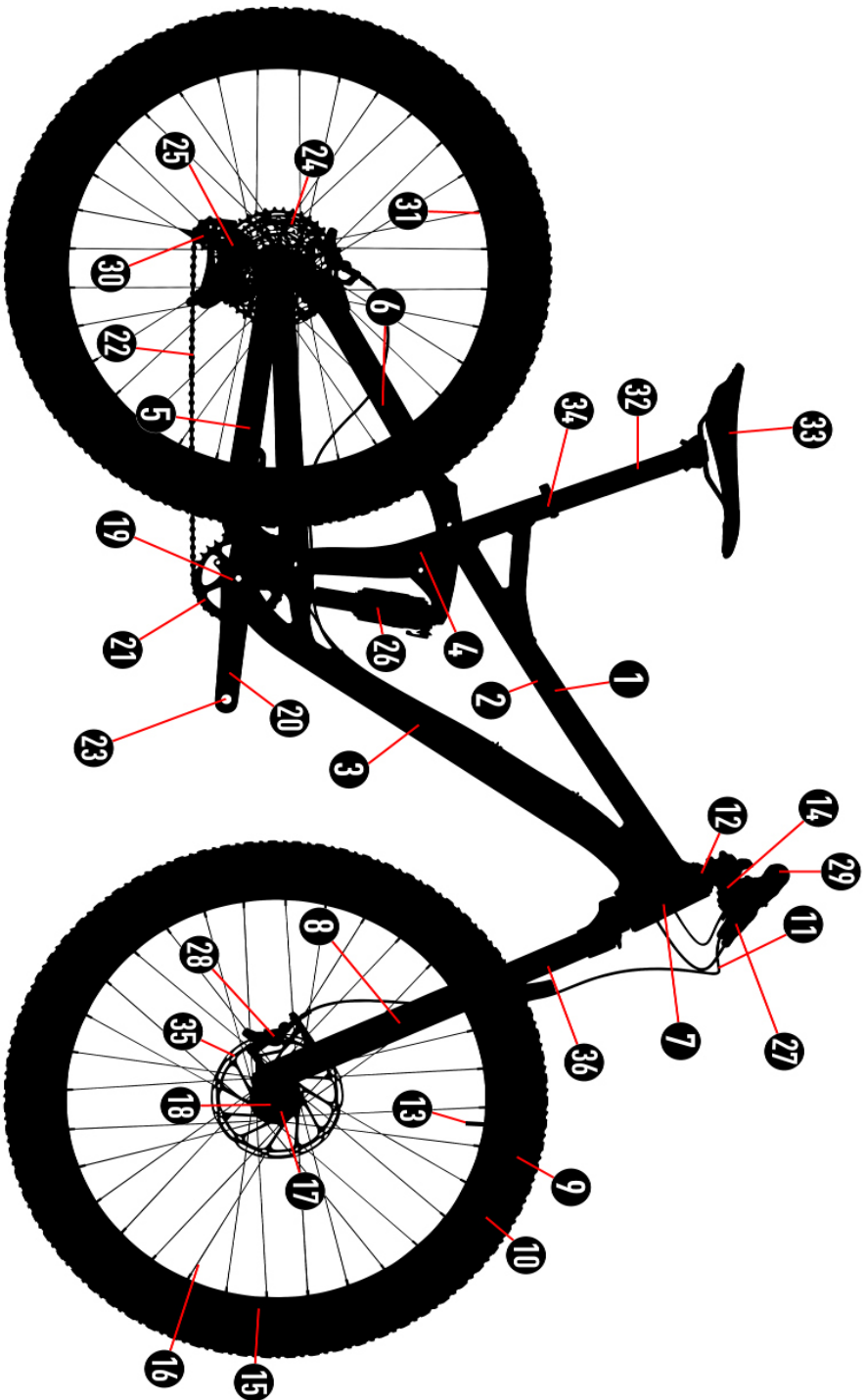

- | | | | |
|---------------|--------------------|-----------------------|----------------------|
| 1. Frame | 11. Cable housing | 21. Chain rings | 31. Spoke nipple |
| 2. Top tube | 12. Headset | 22. Chain | 32. Seat post |
| 3. Down tube | 13. Valve | 23. Pedal | 33. Saddle |
| 4. Seat tube | 14. Stem | 24. Cassette | 34. Seat collar |
| 5. Chain stay | 15. Rim | 25. Rear derailleur | 35. Brake disc |
| 6. Seat stay | 16. Spokes | 26. Rear suspension | 36. Front suspension |
| 7. Head tube | 17. Hub | 27. Levers | |
| 8. Fork | 18. Quick release | 28. Brake | |
| 9. Wheel | 19. Bottom Bracket | 29. Handlebars | |
| 10. Tire | 20. Crankarm | 30. Derailleur pulley | |

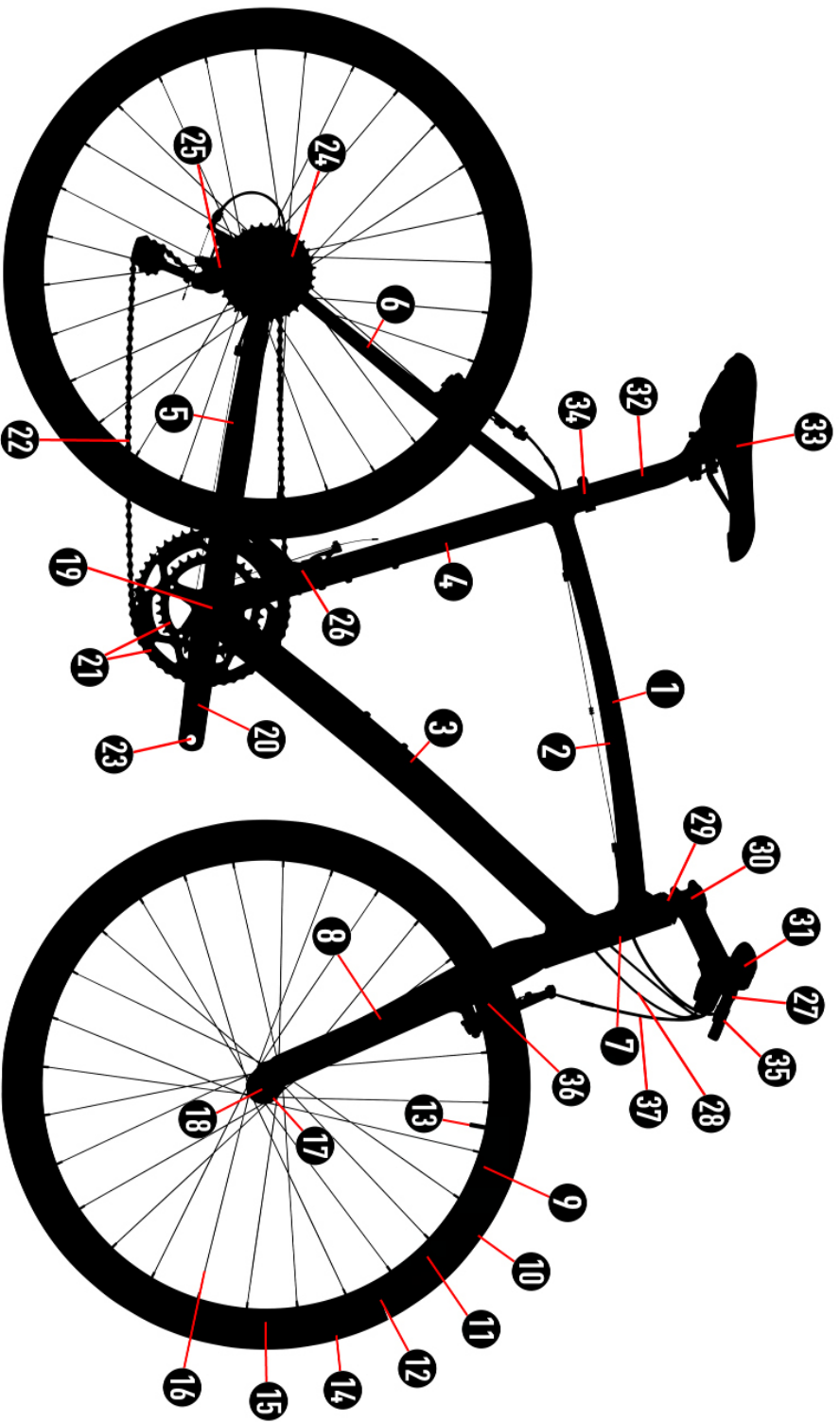

- | | | | |
|---------------|--------------------|----------------------|-----------------|
| 1. Frame | 11. Tread | 21. Chain rings | 31. Handlebar |
| 2. Top tube | 12. Sidewall | 22. Chain | 32. Seat post |
| 3. Down tube | 13. Valve | 23. Pedal | 33. Saddle |
| 4. Seat tube | 14. Inner tube | 24. Cassette | 34. Seat collar |
| 5. Chain stay | 15. Rim | 25. Rear derailleur | 35. Brake lever |
| 6. Seat stay | 16. Spikes | 26. Front derailleur | 36. Caliper |
| 7. Head tube | 17. Hub | 27. Shifter | 37. Brake cable |
| 8. Fork | 18. Quick release | 28. Shifter cables | |
| 9. Wheel | 19. Bottom Bracket | 29. Headset | |
| 10. Tire | 20. Crank | 30. Stem | |

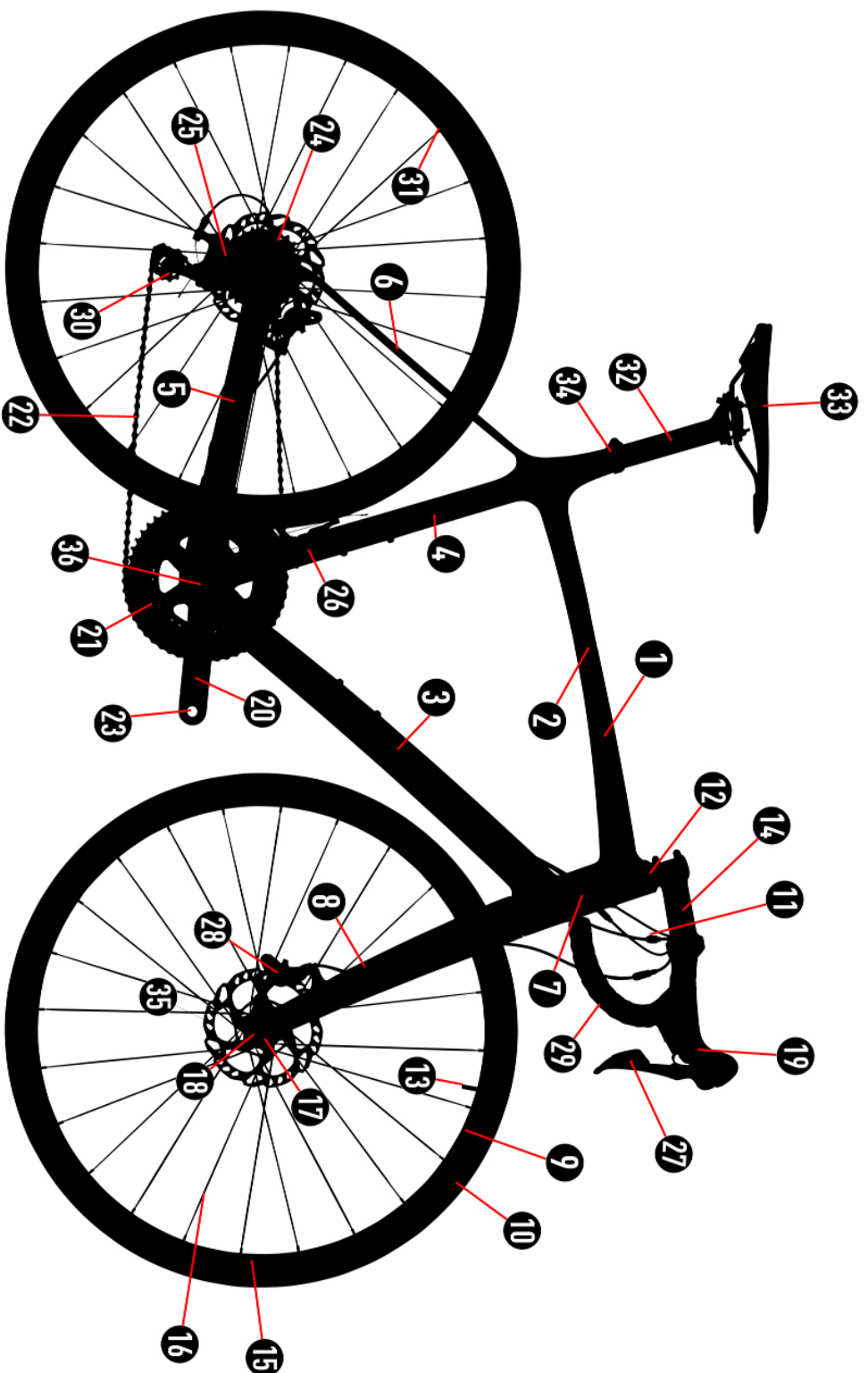

- | | | | |
|---------------|--------------------|-----------------------|------------------|
| 1. Frame | 11. Cable housing | 21. Chain rings | 31. Spoke nipple |
| 2. Top tube | 12. Headset | 22. Chain | 32. Seat post |
| 3. Down tube | 13. Valve | 23. Pedal | 33. Saddle |
| 4. Seat tube | 14. Stem | 24. Cassette | 34. Seat collar |
| 5. Chain stay | 15. Rim | 25. Rear derailleur | 35. Brake collar |
| 6. Seat stay | 16. Spokes | 26. Front derailleur | 36. Crankset |
| 7. Head tube | 17. Hub | 27. Levers | |
| 8. Fork | 18. Quick release | 28. Brake | |
| 9. Wheel | 19. Bottom Bracket | 29. Handlebars | |
| 10. Tire | 20. Crankarm | 30. Derailleur pulley | |



THE BICYCLE USE

CHILD BICYCLE



This is a set of conditions for operation of a children's bicycle under appropriate parental supervision in a manner consistent with the child's bicycling skills. Bicycles intended for this use are "sidewalk bicycles."

Weight limit : 80 lb (36 kg)

CONDITION 1



This is a set of conditions for the operation of a bicycle on a regular paved surface where the tires are intended to maintain ground contact.

Weight limit : Road bicycle, triathlon, time trial, speed bicycle : 275 lb (125 kg)
Adult tricycle, standard pedelec electric-assist bicycle : 300 lb (136 kg)
Tandem : 550 lb (250 kg)

CONDITION 2

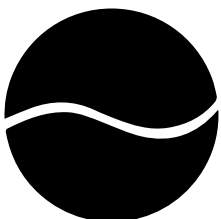

This is a set of conditions for the operation of a bicycle that includes Condition 1 as well as unpaved and gravel roads and trails with moderate grades. In this set of conditions, contact with irregular terrain and loss of tire contact with the ground may occur. Drops are intended to be limited to 15 cm (6 in.) or less.

Weight limit : Hybrid, DuoSport with 700c wheels, tires wider than 28c : 300 lb (136 kg)
Urban or City bicycle : 350 lb (158 kg)
Open road : 275 lb (125 kg)

CONDITION 3

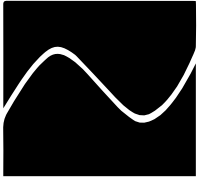

This is a set of conditions for operation of a bicycle that includes Condition 1 and Condition 2 as well as rough trails, rough unpaved roads, and rough terrain and unimproved trails that require technical skills. Jumps and drops are intended to be less than 61 cm (24 in.).

Weight limit : 300 lb (136kg)

CONDITION 4

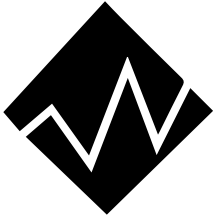

This is a set of conditions for operation of a bicycle that includes Conditions 1, 2, and 3, or downhill grades on rough trails at speeds less than 40 km/h (25 mph), or both. Jumps are intended to be less than 122 cm (48 in.).

Weight limit : 300 lb (136 kg)

CONDITION 5



This is a set of conditions for operation of a bicycle that includes Conditions 1, 2, 3, and 4; extreme jumping; or downhill grades on rough trails at speeds in excess of 40 km/h (25 mph); or a combination thereof.

Weight limit : 300 lb (136 kg)

⚠ WARNING: If your use of a bicycle applies more stress than the use Condition for which it is intended, the bicycle or its parts can have damage or break. A bicycle that has damage could decrease your control and cause you to fall. Do not ride in Use conditions that apply more stress than the limits of the bicycle. If you are not sure of the limits of the bicycle, consult your dealer.

4.1 Maximum luggage weight

- Find your bike on top of the Bicycle use section
- Lookup the Maximum Allowable Weight Limit of the bike model.
- Determine the rider weight, which includes all riding gear.
- Determine the cargo weight, which includes the weight of any additional accessories.
- Subtract the rider weight from the recommended max weight. The result is the amount the rider is allowed for cargo weight, up to the cargo weight limit prescribed for the bike model.

Only bikes fitted with load bearing external inserts are suited for luggages carrying.

Always use luggage carriers suited for your bicycle.

Never exceed maximum allowable weight limit.



FUNDAMENTALS OF CYCLING

5.1 Getting started

It is strongly recommended that you read this manual thoroughly before your very first ride. Make sure you understand the following points and be sure to refer to the detailed sections if you have any doubts. Remember that your authorized Devinci dealer is also available to answer your questions.

5.1.1 Bike Dimensions

First, you should know the answers to the following questions:

- *Is the size of your bike adequate for you? To check, refer to section 5.2.1. A bike that's too large or too small results in loss of stability and could make you fall.*
- *Is your saddle properly adjusted? To check, refer to section 5.2.2. Before adjusting the saddle by yourself, make sure you respect the minimal insertion height by referring to section 7.2.*
- *Have you correctly tightened the saddle and the seat post? If so, you shouldn't get any movement whatsoever.*
- *Are the handlebars and the stem in the right position for you? Before adjusting, make sure you refer to section 5.2.3 to learn how to do it the right way.*
- *Are the reach and angle of your brakes convenient for you? It is possible to adjust your brakes to make them more comfortable to use. Please refer to section 5.2.4.*
- *Do you know precisely how everything works on your bike? If you to have any doubts, do not hesitate to contact your authorized Devinci dealer who will be pleased to describe and teach the functioning of every mechanism to you.*

5.1.2 Security and Bicycling

A regulation standard helmet by CSA (Canada), CPSC, Snell, ASTM (America) or CEN (Europe) is an essential piece of equipment. Do you have one? It is imperative that you ALWAYS wear a regulation standard helmet when riding your bike. Also, make sure it fits your head, that it is well-adjusted and that the chin strap is securely buckled. The use of a poorly adjusted, wrongly positioned and/or incorrectly attached helmet may cause serious injury and could even lead to death.

Do you own other specific safety equipment? In certain provinces or states, you may be obliged to use other safety equipment. It is your responsibility to know and respect the safety rules in effect wherever you ride your bike.

Are you familiar with the use of your wheel quick releases? If not, make sure you refer to section 7.1 to understand their functioning. The use of a bike with incorrectly adjusted wheel quick releases is very dangerous since the wheel could become loose or even unlock and fall, causing damage and/or serious injury that could lead to death.

Do you know how to operate toe clips or clipless pedals? If your bike is equipped with one or the other device and you don't fully understand their functioning please refer to section 7.6 or 7.7. It is very important that you acquire the skills to safely engage and disengage these pedal models. In order to do so, you need to take time in a safe place to practice and learn how they work, one foot at a time. The technique is tricky at first and there is a risk of falling, which could cause injuries.

Is your bike equipped with a front suspension? If so, refer to section 7.8. When braking, a weight transfer tends to compress the front suspension, resulting in a lifting force applied to the rear of your bike that could throw you over the handlebars. It is important that you learn how to use a bike equipped with suspensions in a safe place before doing a real ride. Consult your suspension user manual for more information on how to adjust your suspension. Safety mechanical inspection.

It is crucial that you make a rigorous mechanical inspection before using your bike. Refer to section 5.4 to find out precisely what has to be checked.

Congratulations, you are now up for your first ride!

Wearing your helmet, go get acquainted with your new bike. We recommend you do a short ride to familiarize yourself with the operations of all the different components.

Make sure you learn to brake, to shift gears, engage and disengage your toe clips or clipless pedals as well as understanding how your suspension responds and operates. This learning curve is inevitable and will make you appreciate much more the rides that follow by making them safer at the same time.

Don't forget to read the manual in its entirety!

5.2 Tuning your bike according to your morphology

It is very important that your bike be the right size for you. A bike that is either too large or too small is likely to be harder to control and less comfortable.

⚠ WARNING: If the size of your bike is incorrect, you risk losing control and falling. If the size happens to be incorrect, ask your authorized Devinci dealer to exchange it before you start using it.

5.2.1 Dimensions

Your authorized Devinci dealer will help you choose the right size of bike according to the information provided. If the bike was purchased by someone else, it is imperative that the main user confirms that the size is right before using it. If you selected your bike yourself at your dealer, your dealer will indicate what model is best suited for you.

First of all, the simplest way to check your frame size is to check the standover height. This is defined as the distance between your crotch and the top tube of the frame when standing over the bike with one foot on each side of it. Before you measure it, make sure you wear your bike shoes. Between the saddle and the handlebars as shown on figure 1, place your feet on the ground and jump on your heels. Has your crotch touched the top tube? If yes, your bike is too big for you.

If you intend to use your bike only on paved surfaces, then aim for a standover height of at least 2.5cm. If you intend to use it on bike paths and on unpaved roads, then aim for at least 7.5cm. Finally, if you expect to do some off-road or mountain biking, then you should aim for a standover height of more than 10cm.



Figure 1



Figure 2

5.2.2 Saddle positioning

In order to achieve greater comfort and optimal performance, the saddle should be positioned and adjusted properly. Your authorized Devinci dealer has already placed the saddle in a general position that is likely to satisfy most people. However, if you feel like it could be better, then do not hesitate to go back to your authorized Devinci dealer to have it positioned perfectly. You could also complete the following operations yourself if you have the right tools and necessary skills.

There are three different settings for a saddle:

Refer to figures 3,4,5,6 to determine the right position of your saddle.

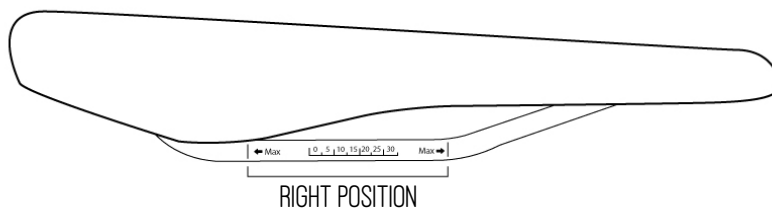

Figure 3

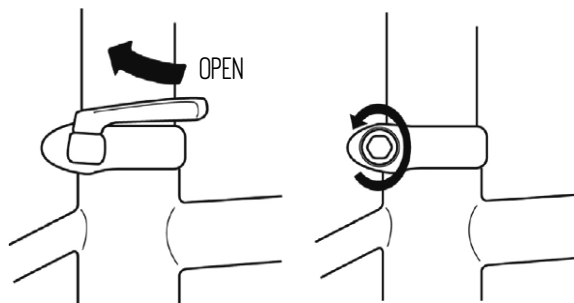

Figure 4

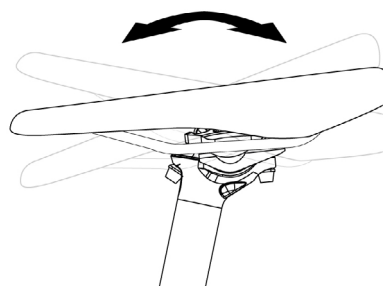

Figure 5

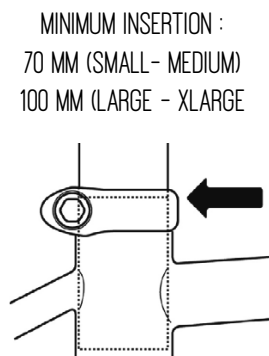

Figure 6

A. The Height

The height of your saddle depends on the length of your legs. Generally, we assume your saddle is well adjusted when you can barely touch the pedal at its lowest position with your heel, when seated on the saddle. The procedure goes as follows: sit on your saddle, place your heel on the pedal and extend your leg to position the crank arm parallel to the seat tube. Your saddle is too low if your leg is bent at the knee while your heel touches the pedal. On the other hand, it is too high if your hip does not remain straight (see figure 2). Your saddle needs to be adjusted until the ideal position is obtained.

In order to adjust the height of your saddle, you will need to loosen the quick release of the seat collar bolt, referring to figure 4 to determine which one you have. Then, move the seat post up or down according referring to figure 4 to determine which one you have. Then, move the seat post up or down according to your needs. Check the straightness of the saddle with respect to the length of the bike and tighten the seat collar carefully to firmly immobilize the seat post.

⚠ WARNING: Your seat post has a minimum insertion line which limits the maximum height you can safely reach. Under no circumstances should this line be visible after positioning the saddle (see figure 6). Placing the saddle otherwise could result in a rupture of the seat tube inducing a loss of control that could lead to serious injury or even death.

B. The Fore-and-aft positioning

Loosen the clamp by referring to figures 3, 4 and 5 and slide the saddle toward the front or the back as desired. First, place the saddle in the middle and make it slide in the desired direction until the most comfortable position is reached.

C. The Tilt

Even though many cyclists opt for a horizontal saddle, a few prefer to have it tilted. If this interests you and your saddle allows it (see figure 7), just loosen the saddle clamping mechanism and tilt the saddle as desired. Be sure to tighten back the mechanism firmly.

⚠ WARNING: After moving your saddle, reselect recommended torque and do it before attempting to ride your bike. In order to make sure it is properly clamped, grab the two ends of your saddle and try to move it up, down, sideways, try to tilt it and even twist it every possible way. If it moves, contact your authorized Devinci dealer.

Small changes in your saddle positioning are enough to increase both your comfort and performance levels. It is strongly recommended that you adjust the saddle in one direction at a time.

Do it many times, little by little, until you find the best position for you.

If you have not found a comfortable configuration after adjusting your saddle in every direction, maybe another type of saddle would suit you better. Everyone is different and that could explain the abundance of different saddle models on the market, offering a myriad of sizes, shapes and stiffness. Your dealer can guide you in the process of choosing an appropriate saddle that will suit your needs and expectations.

⚠ CAUTION: Riding a bike equipped with a saddle that does not correctly support your pelvic area can induce pain or numbness. Also, injuries to your nerves and to your blood vessels could result from an inappropriate saddle. If you happen to feel pain or numbness, adjust your saddle differently. If it persists, contact your authorized Devinci dealer to find out about ergonomic models that might suit you better.

5.2.3 Handlebar positioning

If your bike has a stem clamped directly on the outside of the steer tube, your authorized Devinci dealer should adjust your handlebars height by using cylindrical spacers above or under it.

Do not attempt this modification by yourself, ask your authorized Devinci dealer instead.

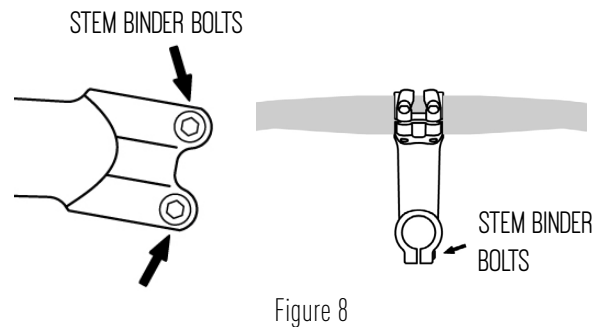
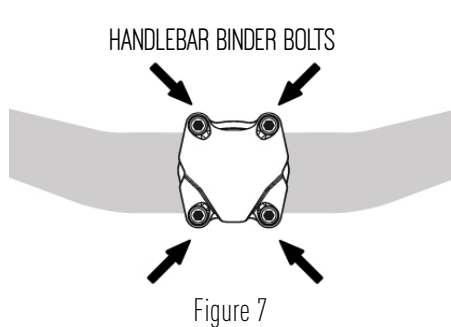

On many bikes, it is possible to adjust the height of the handlebars slightly yourself by changing the stem height. To do so, loosen the stem clamping bolt by a few turns as shown on Figure 8. Use a rubber hammer to move the stem if it appears to be jammed. You can now adjust the respect recommended torque of the stem and tighten back the bolt properly once you have reached the desired setting. You should never be able to move the alignment of the handlebars and the stem with your hands. Moreover, Always leave at least a 5mm spacer on top of the stem. It is not recommended to make this modification by yourself, this one requires a certain amount of experience. Ask your authorized Devinci dealer if you're in doubt.

Now check if your handlebars turn normally and that your brakes are working properly.

⚠ CAUTION: On a few bike models, the handlebars height adjustment could modify the tension in the front brake cable, resulting in the malfunctioning of your front brakes. If the brake pads are closer or further apart from the rim, contact your authorized Devinci dealer before using your bike to have your brakes adjusted.

If you wish to modify the angle of your handlebars, you can loosen the bolt of its clamping system, rotate the handlebars as desired, center them and tighten the bolt with recommended torque. You shouldn't be able to change the alignment of the handlebars with the stem with your hands.

⚠ WARNING: A weak tightening of the retaining bolt of your stem or of the handlebars is likely to decrease the handling of your bike and risk causing a loss of control and a fall. Place yourself facing the bike, squeeze the front wheel between your legs and try turning the handlebars. If you can change the alignment between your stem and your front wheel, the bolts are definitely not tightened enough. The alignment of the handlebars with respect to the stem should also be identical.

5.2.4 Brake levers and shifters position

Upon delivery of your bike, your authorized Devinci dealer has assembled the brake levers and shifters in the standard position. It is possible to modify their angle and their position with respect to the handlebars. Ask your authorized Devinci dealer to adjust them or to show you the procedure.

5.2.5 Brake tuning

Many models offer the possibility of adjusting the reach of your brake levers and shifters. Make sure you are familiar with which brake is the front and the rear one. If you feel it is difficult to brake or to shift gears properly, then ask your authorized Devinci dealer to adjust them according to your needs.

5.3 Safety equipment

⚠ WARNING: Many countries have laws that require the use of certain safety devices. It is your duty to know the legislation of the countries you use your bike in and to comply with those requirements by using these safety devices.

5.3.1 Helmet

Even though the use of the helmet is not required in every country, it is strongly recommended to use one that is regulation standard (see section 5.1.2). Your authorized Devinci dealer has many good-looking models that will certainly meet your expectations.



Right



Wrong

Figure 9

Make sure the helmet you choose is well-adapted to your head, not to your look. Always place it correctly as shown on the Figure 9 and secure it completely. Ask your authorized Devinci dealer to guide you in the process of selecting your helmet.

⚠ WARNING: You should always wear a regulation standard helmet when riding your bike. It is important to secure the chin strap. Consult your helmet user manual for more information. The use of a regulation standard helmet can prevent serious or even deadly injury.

5.3.2 Reflectors

The reflectors are an essential component of your bike that greatly improve your safety. They are designed to reflect car lights and street lights and therefore, make you easier to spot.

⚠ WARNING: Run a regular check to verify that your reflectors and their mounting brackets are functional, clean, straight and solidly mounted. Consult your authorized Devinci dealer if they are broken or damaged, to get them replaced.

⚠ WARNING: Never remove your front or rear reflectors or their mounting brackets, because they are designed to push away from the brake cables and prevent interference with the wheels in the event they break. Such interference could result in sudden wheel stop, leading to loss of control that could cause serious or even deadly injuries.

⚠ WARNING: Never remove your bike reflectors. They are very important safety devices that help increase significantly your visibility. Indeed, if you remove them, there is a risk of collision between you and the other road users who will not see you properly. Being hit by a car can result in very serious injuries or even death.

However, do not forget that reflectors are not intended to replace lights. Be sure to equip your bike with lights according to the local legislation.

5.3.3 Lights

If you use your bike at night, it has to be equipped with lights to make your surroundings visible and make you visible to your surroundings. Therefore, you are required to have a white front light and a red one on the back, when riding at night. Your authorized Devinci dealer can guide you in choosing the proper lighting devices.

⚠ WARNING: The reflectors are not intended to replace lights. You are required to equip your bike with lighting devices according to the legislation in effect in the areas where you use it. It is dangerous to ride without reflectors and lights at night or when the visibility is poor.

5.3.4 Pedals

Performance bikes are often equipped with pedals with sharp edges and dangerous parts. These are designed to increased security and performance by improving their adherence with the cycling shoes. If you have this pedal type, be careful and practice their use on an unpaved surface. Depending on your level, you might want to choose a less aggressive pedal model.

Consult your authorized Devinci dealer to choose a convenient pedal model.

5.3.5 Eyewear

When riding a bike, there is a high risk of getting dust, mud, bugs and other projectiles in the eyes. Therefore, it is strongly recommended that you wear eye protection adapted to riding.

Consult your authorized Devinci dealer to receive assistance choosing your eyewear.

5.4 Mechanical safety inspection

5.4.1 Nuts, bolts and clamps

Lift the front wheel five to ten centimetres and let it bounce heavily on the ground. Nothing should be loosened. Do a quick visual and physical inspection of every part of your bike to make sure of that. In case you find any loosened parts or accessories, tighten them immediately with the proper tools. If you have any doubts, ask your authorized Devinci dealer.

5.4.2 Tire and wheels

Your tires must be properly inflated. To determine the correct tire pressure range for a specific tire, please refer to the tire pressure range specified on the sidewall of the tire. Refer to section 7.5 for more detailed instruction and information.

Make sure the tires are still in good condition. Turn the wheels slowly and check for damage, cuts or excessive wear on the tires. Replace the damaged tires before using your bike. Redo the same exercise, checking the wheels this time. Verify their straightness and trueness, the absence of lateral loosening and the constancy of the distance between the brake pad and the rim. Consult your authorized Devinci dealer if anything looks suspicious or to get your wheels true.

⚠ WARNING: The brake functioning largely depends on your wheel state. Truing a wheel requires very specific skills and tools. Never attempt this operation if you lack the skills or the tools. Instead, consult your authorized Devinci dealer.

5.4.3 Brakes

To check that your brakes are functioning properly, press firmly on the brake levers. Make sure the brake pads close in correctly on the rim. Also, check that the brake cable stays in place. Do the brake pads touch the rim when pressing the brake levers at 2.5cm? Is the brake disc centered in the callipers? Is the disc in contact with the brake pads when not braking? Can you obtain maximum braking power without having the brake levers touching the handlebars? If you found any problems while answering these questions or if you have any doubts concerning your brakes after this inspection, you should have your brakes checked immediately. Make sure to use genuine replacement parts that are adapted to your system. Do not use your bike until the brakes are fully functioning. Refer to section 7.3 for more detailed instructions or contact your authorized Devinci dealer.

⚠ WARNING: Using a bike with worn brake pads or simply improperly adjusted brakes is very dangerous and can cause serious injury or even death.

5.4.4 Wheel and seat post quick releases

Check that your wheel seat post and quick releases are properly clamped. Refer to section 7.1 for more information.

⚠ WARNING: The use of a bike with loosened quick releases is extremely dangerous. A wheel quick release that is improperly tightened may cause wheel wobbling. This could cause damage to your bike and result in injury and could even lead to death.

5.4.5 Handlebar and saddle alignment

Is your saddle parallel to the top tube of your frame? Is your wheel aligned with your stem and perpendicular to your handlebars? Are these parts tightened properly? You should never be able to move any of them with your hands.

5.4.6 Handlebar extremities

Are your handling grips properly attached to the handlebars? Are they in good shape? If not, consult your authorized Devinci dealer to get new grips. If they are missing the end plugs, install new ones before riding your bike.

⚠ WARNING: If your handlebar grips are loosened or damaged, you risk losing control of your bike and falling. If the end plugs of your handlebar are not protected, you could cut yourself or get seriously hurt.



FOR A SAFE AND SMART EXPERIENCE

6.1 Fundamentals of cycling

- *Proceed to the mechanical safety inspection (refer to section 5.4) before every use;*
- *Always wear a standard approved helmet (see section 5.1.2);*
- *Keep moving parts of your bicycle away from your body during maintenance and riding, there is a risk of entrapment.*
- *Wear shoes that hold your feet tightly and offer a good adherence with the pedals. Never use your bike wearing sandals or just barefoot;*
- *Make sure you know and master every part of your bicycle;*
- *Adapt your speed to your environment, to the riding conditions and to your level of skills. Make sure you always fully control your bike and that you are at ease with the speed you are going. Never forget the direct correlation between speed and the risk of losing control. Respect your national legal requirement when riding on public roads;*
- *Never do jumps with a bike not designed for this purpose. When landing, huge forces are distributed through the bike, increasing stress levels exponentially.*
- *Wear clothes with bright and visible colors that are not likely to get stuck in the moving parts of your bike. Always avoid loose clothing.*

⚠ WARNING: Jumping, riding half-pipe, attempting aerial maneuvers or carrying heavy loads are very dangerous and are not recommended uses of your bike, since they imply high risk of damaging your bike or causing serious injury that could even lead to death.

6.2 Road bike Safety Code

- *Know traffic laws and other specific regulations of the region where you ride. Many cities have adopted rules concerning bicycling, sidewalk use, bike licensing, etc. Many countries also have laws concerning helmets and child carriers. Some even have specific traffic laws for bikers;*

- *Ride carefully, anticipating and ready to avoid:*
 - a. *surrounding cars that turn, engage, disengage, brake or follow you;*
 - b. *motorist opening their doors on your path;*
 - c. *pedestrians crossing the street;*
 - d. *kids playing on the side of the road;*
 - e. *gully holes, railroad tracks, pot holes, bridge expansion joints, debris or any other objects obstructing your path that might cause damage to your bike and loss of control;*
 - f. *Any other distraction you may encounter on your path;*
- *The roads are busy, be careful and respect the other cars, trucks, motorcycles and bicycles. Respect the traffic laws, be patient and tolerant even if others aren't;*
- *Learn how to properly hand signal your actions, like right or left turns and stops;*
- *Respect the traffic laws: Obey traffic lights and stop signs, look both ways before crossing at an intersection;*
- *Observe priority rules and try not to do unexpected maneuvers;*
- *Make sure you stay focused at all times and anticipate the possibility of a motorist neglecting, forgetting or even not noticing your presence;*
- *Never transport another person, unless it is a young child wearing a regulation standard helmet in a safe and securely mounted standard child carrier;*
- *Always use the bike path if possible. On the road, stay on the right side as far as possible from the traffic;*
- *Avoid as much as possible riding in bad weather with poor visibility, in dark areas or when you are tired. These conditions are dangerous and tend to substantially increase the risk of injury;*
- *Never use headphones while riding since they impair your ability to hear the traffic sounds or the sirens of emergency vehicles;*
- *Do not transport luggage that could impair your visibility, disturb the stability and maneuverability of your bike or get jammed in moving parts;*
- *Never try to pull or get pulled by any other vehicle;*
- *Do not ride under the influence of drugs or alcohol;*
- *Do not attempt tricks, wheelies, jumps or any other stunts with your bike.*
- *Be aware of lighting and reflector requirements specific to your area;*

6.3 Off-road bike Safety Code

- *When riding off-road, help is often far away. Be cautious and prepared; bring all the necessary equipment presented in section 8.2;*
- *Never ride by yourself in remote areas. Even when accompanied, inform at least one person of your destination and an estimated return hour;*
- *Ride only in mountain biking trails. Do not enter private land and areas with forbidden access;*
- *Since it is more dangerous and technically more difficult to do mountain biking than road biking, start by practicing in an easy and safe place;*
- *You are not alone on the trails, make sure you respect the other users and be tolerant;*
- *Always give priority to pedestrians and be careful not to disturb the fauna. Keep a good distance so as not to frighten them and to avoid their unpredictable moves that could cause losses of control and make you fall;*
- *Always stay on trails to prevent damage to the environment. In mud, be careful not to contribute to the soil erosion. You are likely to disturb the fauna and the flora by not following the marked trails;*
- *It is your duty to minimize your impact on the environment. Ride responsibly by leaving nature as you found it and by disposing of your garbages in the proper receptacles.*

6.4 Riding at night

It is dangerous to ride your bike at night. It is not recommended to let children ride near roads at dusk or at night. Adults also should avoid it as much as possible.

⚠ WARNING: It is dangerous to use a bike without reflectors or a lighting system at night, at dusk or when visibility is reduced. You could risk serious injury or even death.

If you ride your bike at dusk or at night, make sure you are completely visible by taking the following precautions:

- *Wear clothes with bright colors and accessories that make you easier to see, such as reflective vests, reflective arm, wrist, ankle and helmet bands and flashing lights. This will help the motorists and pedestrians detect your presence;*
- *Run a regular check to verify that your reflectors and their mounting brackets are functional, clean, straight and solidly mounted;*
- *Install a lighting system for the front and the rear of your bike that runs on batteries or by a dynamo. Ask your authorized Devinci dealer for more information;*
- *Be careful not to hide your reflectors and/or lights with your clothes or any objects you are carrying.*

Adapt your behaviour:

- *Ride slowly;*
- *Do not ride in areas with lots of traffic, on roads with a speed limit higher than 50km/h;*
- *Avoid very obscure or dangerous areas;*
- *Use only paths that are familiar to you.*

6.5 Riding on wet surfaces

⚠ WARNING: Rain tends to make roads, paths and trails slippery and increases the braking distance for you as well as for other users you may encounter. Visibility is generally negatively affected. The risk of accident is substantially increased on wet surfaces.

As mentioned earlier, wet surfaces tend to be very slippery, resulting in a substantial loss of maneuverability and braking power. To be sure to safely stop on a wet surface, you must diminish your speed and you must brake earlier and more progressively than normal. In fact, you would not want your wheels to lock up and start skidding. Refer to section 7.3.1 for more details.

6.6 Extreme and competitive use

If you intend to participate in competitions or if you practice downhill, you accept that you are taking greater risks that could cause serious injury or even death. In downhill, you risk reaching speeds as high as those attained by off-road motorcycles and you are then exposed to a similar level of danger. Always wear complete safety equipment including full-face helmet, full finger gloves and a body armor that fully protects your back. Make sure your bike and equipment are in order by having them inspected by your authorized Devinci dealer. Ask the expert riders and the trail managers for information regarding the conditions and the required materials. It is your responsibility to check that you have the correct equipment, including your bike and that it is in working perfect order.

⚠ WARNING: Downhill biking can result in serious accidents. Always wear the proper safety equipment and make sure your bike is in perfect working order. Competitive riding implies higher crash risk, and can cause loads for which your bike is not designed. Therefore, any damage to your bike resulting from competitive use is not covered under the lifetime warranty.



TECHNICAL INFORMATION

In order to increase your performance, your safety as well as your fun, it is essential that you understand thoroughly how your bike and its components work. Even if you are an expert rider, the new generation bikes have so many innovations and new technology that you could end up surprised. It is, therefore, strongly recommended you go through this section no matter how much experience you have. For more information, always refer to your authorized Devinci dealer.

7.1 Wheels

7.1.1 Assembly and disassembly

⚠ WARNING: Using a bike with quick releases that are not tightened enough means you risk losing the wheels, resulting in damage to bike and leading potentially to serious injury or even death. It is, therefore, essential that you:

- Ask your authorized Devinci dealer to explain how the wheels quick releases work so that you can assemble and disassemble them safely;
- Learn how to safely use a quick release so that you can apply this knowledge;
- Make sure your wheels are properly clamped before every ride.

A. Adjusting the quick release system

The quick release uses a cam mechanism to exert a significant force on the wheel hub when placed in the closed position and a small force in the open position. Since it is adjustable, you need to learn how to operate it to ensure optimal use and a safe binding.

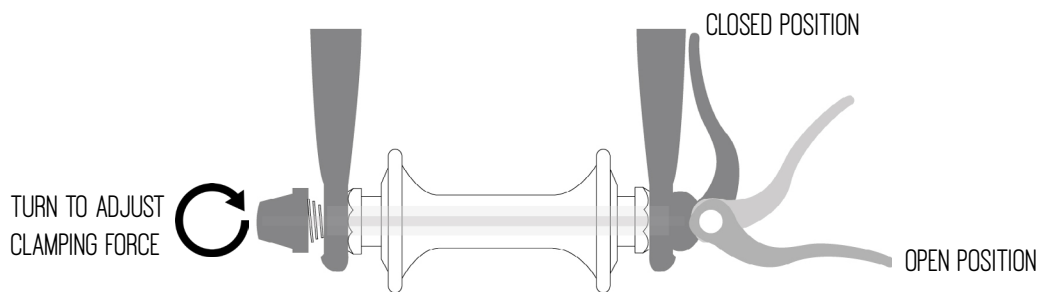

Figure 10

⚠ WARNING: You need to use the cam mechanism when clamping your wheel with a quick release to achieve proper binding force, by switching the lever from the opened to the closed position. If you hold the level with one hand and you screw the nut to clamp the wheel, it will never be safely tightened. Instead, you need to switch the lever from the opened to the closed position with a very significant restriction force. The nut helps you adjust the amplitude of that force by screwing or unscrewing it.

It is the power of the cam that maintains the wheel in place. It squeezes the wheel hub in between the fork arm ends or dropouts when switching the lever from the opened to the closed position. The tightening force depends on the torque applied on the adjusting nut. To increase the tightening force, you need to turn the adjusting nut clockwise while holding the lever with the other hand. To reduce it, turn the adjusting nut counterclockwise again holding the lever. Less than half a turn can make the difference between a safe and an unsafe tightening. The mechanism should emboss the dropout-ends when closed in the locked position. Refer to Figure 10.

Notice: The quick release mechanism is installed on the wheel hub by its manufacturer. Never remove the mechanism from the wheel hub unless you need to repair it. Consult your authorized Devinci dealer for the repair of a wheel hub.

B. Front wheel alternative devices

On many models, the front fork is equipped with an alternative retention device that prevents the wheel from disengaging in case of poor quick release installation. This device, integrated directly to the fork by the processes of machining or casting, shall not replace, under any circumstances, the prescribed adjustment of the quick release. Removing the auxiliary retention device voids your warranty.

⚠ WARNING: It is very dangerous to use a bike with a modified or removed auxiliary retention device. The modification or the removal of this device could result in serious injury or even death. This could also lead to the annulment of your warranty.

C. Disassembly and assembly of a wheel equipped with a quick release

a. Front wheel disassembly

- *If your bike has v-brakes, spread the brake calipers as elaborated in section 7.3;*
- *Switch the quick release from the closed to the opened position;*
- *Loosen the adjusting nut of the quick release until the wheel can be adequately removed;*
- *Lift the front of the bike a few centimeters and hit the wheel downward with your hand to disengage it from the fork.*

b. Front wheel assembly

Notice: If your bike has disc brakes, make sure you do not damage the disc, the calipers or the pads in the process of removing the front wheel. Be particularly careful when inserting the disc between the brake pads and the calipers.

- *Turn the quick release lever into the opened position as shown on Figure 10;*
- *Place the fork straight with respect to the bike and insert the wheel between the fork dropouts. The axel must firmly rest in the dropouts;*
- *Maintain the quick release lever at the opened position with one of your hands. Manually tighten the quick release adjusting nut until you feel an adequate resistant torque;*
- *Press the wheel firmly into the dropouts, align the wheel with respect to the fork, align the quickrelease lever with the fork arm and then switch it to the closed position. Make sure the quick release lever ends up being parallel to the fork arm as shown on figure 11 and figure 12;*

⚠ WARNING: In order to place the quick release lever into the closed position, you must use leverage with the fork arm. Also, the lever should leave a clear imprint in the palm of your hand for a few seconds. If this is not the case, place the lever back to the opened position and turn the adjusting nut a quarter of a turn clockwise and try again.

- *If you cannot tighten the quick release lever to the closed position, you need to loosen the adjusting nut a quarter of a turn. Then try again;*
- *Reconfigure the brakes back in place and make sure the wheel is properly centered, so that it turns freely without touching the brake pads;*

⚠ WARNING: The auxiliary retention system is not intended to replace adequate tightening of the quick release. If you use your bike and the quick releases are not tightened enough, you risk losing the wheels, damaging your bike and suffering serious injury or even death.

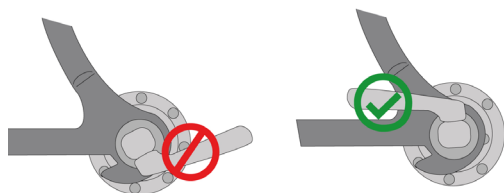

Figure 11

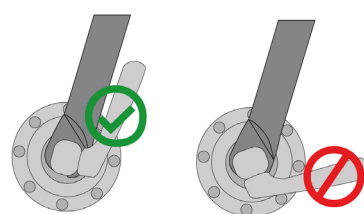

Figure 12

c. Rear wheel disassembly

- Shift the rear derailleur onto the highest gear corresponding to the smallest sprocket;
- If your bike has v-brakes, spread the brake calipers as shown in section 7.3;
- Turn the quick release lever to the opened position as illustrated in Figure 10
- Lift the rear of the bike a few centimeters and push the wheel. Lift the rear of the bike a few centimeters and push the wheel disengage it.

d. Rear wheel assembly

Notice: If your bike has disc brakes, make sure you do not damage the disc, the calipers or the pads in the process of replacing the front wheel. Be particularly careful when inserting the disc between the brake pads and the calipers.

- Shift the rear derailleur on to the highest gear which corresponds to the smallest sprocket;
Turn the quick release lever to the opened position, referring to figure 10. Place the wheel with the quick release positioned on the rear derailleur's opposite side;
- Bring the derailleur body towards the back with one of your hands;
- Place the chain on the smallest sprocket of the cassette. Position the wheel axle in the dropouts and push vigorously.
- Turn the adjusting nut clockwise until it touches the dropout. Turn the quick release lever towards the closed position, making sure the lever is parallel to the seat stay;

⚠ WARNING: The auxiliary retention system is not intended to replace adequate tightening of the quick release. If you use your bike, and the quick releases are not tightened enough, your wheels risk to disengaging, damaging your bike and leading to serious injury or even death.

- If you cannot tighten the quick release lever to the closed position, you need to loosen the adjusting nut a quarter of a turn. Then try again;
- Place the rear derailleur back in place;
- Reconfigure the brake back in place and make sure the wheel is properly centered so that it turns freely without rubbing the brake pads.

D. Assembly and disassembly of wheels without quick release

a. Front wheel disassembly

- *If your bike has v-brakes, spread the brake calipers as elaborated in section 7.3;*
- *Lift the front of the bike a few centimeters and hit the wheel downward with your hand to disengage it from the fork.*

b. Front wheel assembly

- *Place the fork straight with respect to the bike and insert the wheel between the fork dropouts. The axel must firmly rest in the dropouts. The washers should be on the outside of the dropouts, before the nuts;*
- *Press the wheel firmly in the dropouts and align the wheel with respect to the fork. Tighten the nuts firmly on the axel with a 15mm wrench;*
- *Reconfigure the brake back in place and make sure the wheel is properly centered, so that it turns freely without touching the brake pads.*

c. Rear wheel disassembly

- *Shift the rear derailleur to the highest gear which corresponds to the smallest sprocket;*
- *If your bike has v-brakes, spread the brake calipers as shown in section 7.3;*
- *With a 15mm wrench, loosen the axel nuts;*
- *Lift the rear of bike a few centimeters and push the wheel forward then downward to disengage it.*

d. Rear wheel assembly

- *Shift the rear derailleur to the highest gear which correspond to the smallest sprocket;*
- *Bring the derailleur body towards the back with one of your hands;*
- *Place the chain on the smallest sprocket of the cassette. Position the wheel axel in the dropouts and push vigorously as shown on figure 11;*
- *Tighten the axel nuts firmly with a 15mm wrench;*
- *Place the rear derailleur back in place;*
- *Reconfigure the brake back in place and make sure the wheel is properly centered, so that it turns freely without rubbing the brake pads.*

7.1.3 - Risks of tightening without a wheel inserted

⚠ WARNING: Tightening your QR or TA without a wheel can flex your fork or stays excessively and cause severe damage to the structure of your bike.

7.2 Seatpost

Most bikes have a quick release to clamp the seatpost. These work exactly like the wheel quick releases as explained before. Even though it looks like a bolt with a nut and a lever, it is actually a cam mechanism that clamps your seatpost tightly and that facilitates adjusting its height.

⚠ WARNING: If you use your bike and its seatpost quick release is not tightened enough, your seat could move and turn. This could result in a loss of control, leading to serious injury or even death. It is, therefore, essential that you:

- *Ask your authorized Devinci dealer to explain how your quick release works so that you can safely adjust your seat. If you have a bolted seat clamp, respect the prescribed torque values.;*
- *Learn how to safely use a quick release so that you can apply this knowledge. Never grease or oil your seatpost shaft. Ask your dealer about specific seatpost pastes.;*
- *Make sure your seat is properly clamped before every ride. Always follow the minimum insertion guidelines.*

A. Quick release adjustments

It is the power of the cam that maintains the seatpost in place. It squeezes it inside the seat tube when switching the lever from the opened to the closed position. The tightening force depends on the torque applied on the adjusting nut. To increase the tightening force, you need to turn the adjusting nut clockwise while holding the lever with the other hand. To reduce it, turn the adjusting nut counterclockwise while holding the lever. Less than half a turn can make the difference between a safe and an unsafe clamping.

⚠ WARNING: You need to use the cam mechanism when clamping your seatpost with a quick release to achieve proper clamping force, by switching the lever from the opened to the closed position. If you hold the nut in one hand and you turn the lever, the seatpost is never going to be safely clamped. Instead, you need to switch the lever from the opened to the closed position with significant restriction force. The nut helps you adjust the amplitude of that force by screwing or unscrewing it.

⚠ WARNING: To place the quick release lever into the closed position, you must use leverage with the seat tube. Also, the lever should leave a clear imprint in the palm of your hand for a few seconds. If this not the case, place the lever back to the opened position and turn the adjusting nut a quarter of a turn clockwise and try again.

7.3 Brakes

Notice: In order to achieve the optimal braking power, use both front and rear brakes simultaneously.

⚠ WARNING: If you brake suddenly and excessively, you risk falling over your bike and that could cause serious injury or even death.

7.3.1 Brake functioning

First of all, for safety purposes, it is essential you instinctively associate each brake lever with the brake it controls. In North America, the right lever controls the rear brake while the left one controls the front one. On a bicycle, it is the friction between the brake pads and the rims that

allows braking, by transforming kinetic energy into heat. There are also disc brakes that use the same principle but with a disc instead of the wheel rim. In both cases, for the best braking, clean the brake pads and the rim or the disc and make sure there are no traces of lubricant or wax.

Furthermore, you should check that the brakes are easy to reach with your hands. If you feel your hands are too small, that the position is uncomfortable or if you are unable to brake with full power, ask your authorized Devinci dealer. Most of the time, they will be able to tune the reach of the brake levers or install specific grips to solve the problem.

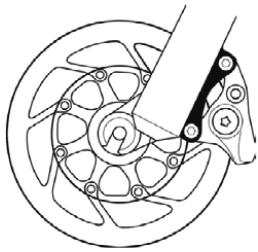

Figure 12

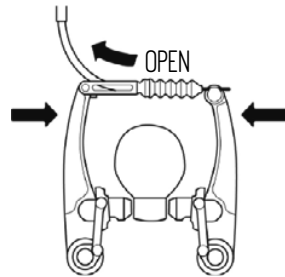

Figure 13

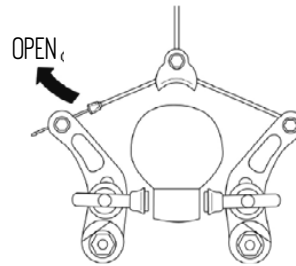

Figure 14

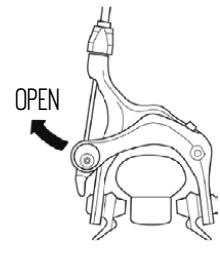

Figure 15

Most brakes possess a mechanism that allows disengaging the brake from the rim when you want to assemble or remove the wheel. Once disengaged, it is impossible to brake. Ask your authorized Devinci dealer to explain clearly how to disengage the brakes on your bike according to the mechanism you have (refer to figures 12 to 15).

Always check that your brakes are operational before using your bike. Brakes are not intended for the sole purpose of stopping your bike, they are also intended to help you slow down. The maximal stopping power can be achieved just before the wheel starts skidding. When the wheels are locked up, a large amount of the braking power is lost and you tend to lose control. You must learn to slow down and brake efficiently without locking up your wheels. This technique is known as progressive braking modulation. Pull the brake lever by progressively increasing the braking power instead of pulling suddenly and excessively. If you feel your wheels starting to lock, smoothly release the lever until you get a normal wheel rotation back. It is very important to adjust the braking force on the wheels according to the surface on which you're riding. To thoroughly understand this technique, we recommend you try walking beside your bike to visualize the effect of pulling the brake levers. You are likely to perceive more easily the moment your wheels lock up and stop rotating.

⚠ WARNING: The disc and linear pull brakes on certain models are extremely powerful. If you have this kind of brakes, familiarize yourself carefully by trying to brake progressively at first. Pull the lever too suddenly could result in loss of control and a fall.

⚠ CAUTION: Disc brakes become very hot after intensive or prolonged use. Be careful not to burn yourself by touching the disc or the caliper.

When braking, the bike starts slowing down, but your body inertia tends to continue forward at the same pace, causing a weight transfer towards the front wheel. If you brake by suddenly locking up the wheels, this weight transfer could throw you over the handlebars. This phenomenon will even be accentuated if you have a front suspension. Indeed, the suspension will compress downward, increasing the weight transfer.

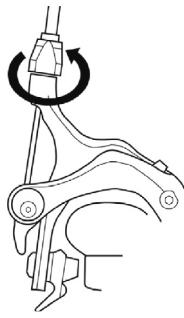

Figure 16

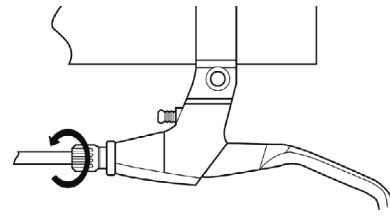

Figure 17

Another factor that affects the braking force is the load on your wheel. Indeed, normal force is directly proportional to the friction force you can reach. As a matter of fact, a wheel with a heavy load on it will allow a higher braking force, while a wheel with a lighter load on it will lock up much sooner. Therefore, you should back up to the rear of your bike when braking with more intensity. This will increase the weight on the rear wheel while decreasing the weight on the front one, it will also shift your center of gravity. This will help reduce the risk on being thrown over your bike. Simultaneously, you should use the front brake with more strength than the rear one. This technique is even more important when riding down steep terrain.

In order to master braking techniques, it is important to practice in a safe place away from traffic, obstacles or any other danger. Make sure you master the lock up limits of your wheels and the weight transfer linked to emergency braking.

When riding your bike on wet surfaces, in rainy weather or on light and running soil, your bike response changes. The tire adherence decreases quickly and your maneuverability is negatively affected. Often, a smaller braking pressure is all it takes to lock up the wheels completely. Furthermore, water and humidity make the brake pads less efficient. In wet weather, make sure you reduce your speed in order to better control your bike.

7.3.2 Brake tuning

If your bike is equipped with hydraulic disc brakes and you suspect something abnormal at your safety mechanical inspection, have it immediately checked by your authorized Devinci dealer.

On the other hand, if your bike is equipped with cable brakes and it fails the safety mechanical inspection, you can try adjusting their strokes by turning their tuning barrel counter-clockwise.

Make sure you screw back the lock nut after the adjustment. If the problem persists, ask your authorized Devinci dealer for assistance. Refer to figures 20 and 21 for visual support.

7.4 Drivetrain

Your bike is equipped with a mechanism of chain and sprockets, also known as a drive train that allows changing the pedaling ratios and optimizes your pedalling power.

Shifting gears will allow you to increase your physical benefits. Using your gears, you can pedal with a higher cadency and a lower resistance, which will help improve your endurance and power. On the other hand, exerting huge forces on your pedals with a low cadency will obtain poor results for your health and your fitness. The numerous gears your bike possesses help you target the optimal cadency in a variety of situations and geographical conditions. The optimal cadency is generally ranged between 60 and 90 turns per minute, depending on your age and your fitness.

7.4.1 Drive train functioning

The drive train mechanism of your bike is divided into:

- A rear derailleur;
- A front derailleur (most of the time);
- A freewheel cassette;
- One to three chainrings;
- A chain;
- One or two shifters.

To calculate the number of speeds available on a bike, just multiply the number of chainrings with the number of rear sprockets on your freewheel cassette. For example, a bike with two chainrings and eleven sprockets on your freewheel cassette has twenty-two speeds.

A. Shifting gears

Many shifter models are available on the market. Devinci has selected shifters to better meet your criteria in terms of ergonomics, performance and price. The figures 18 to 21 illustrate the way the different models work. Check the type of shifters your bike is equipped with before continuing.

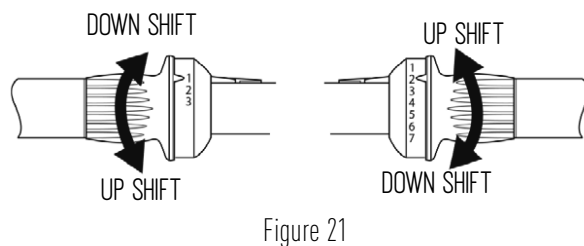
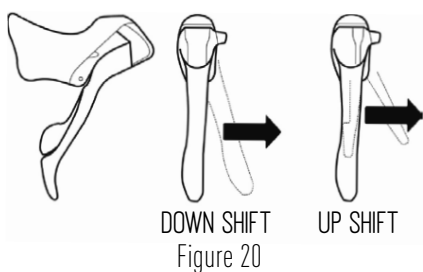
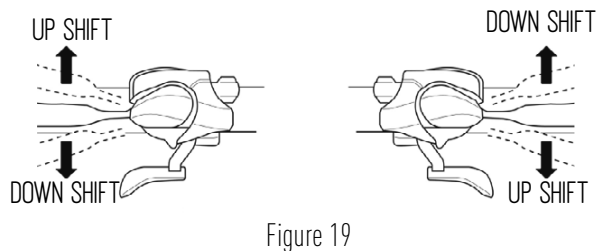
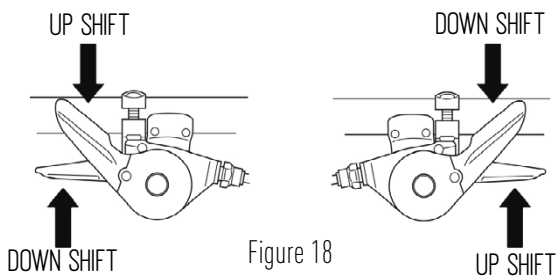

The vocabulary for gear shifting might seem a bit confusing at first. To go to a shorter gear ratio or to a slower gear is designated as a downshift while upshifting refers to the action of going at a longer gear ratio or a faster gear. A slower gear requires less strength than a faster gear. To make that even more complex, the actions on your rear derailleur are opposite to those on your front derailleur. Indeed, the action of down shifting can be achieved in two different ways; lowering the chain on a smaller chainring or raising the chain on a larger sprocket on the freewheel cassette. Refer to sections B and C for more details.

A little trick to help you memorize this is to note that the chain must be closer to the frame in order to down shift and climb a hill or further away to upshift and go faster.

To shift gears, the chain must be tight and rotate in the normal direction. The derailleur works only when pedaling forward.

⚠ CAUTION: Never activate your shifters when pedaling backwards and never pedal backwards after having shifted gears. The gears could jam and damage your bike.

⚠ WARNING: Never send the chain on the larger or the smaller sprocket of the freewheel cassette if your derailleur is not properly adjusted. The chain could jam and result in a fall and serious injury. This also applies to the front derailleur.

B. Front derailleur shifting

It is the left shifter that activates the front derailleur. The chain move from the smaller chainring for easier pedaling (slower gears) to larger ones for harder pedaling (faster gears).

C. Rear derailleur shifting

It is the right shifter that controls the rear derailleur, making the chain moves on the different sprockets of the freewheel cassette. The larger sprockets produce smaller ratios, which necessitate less effort, but require more pedaling cycles to achieve a given distance. The smaller sprockets produce greater ratios, which require more effort but necessitate fewer cycles to achieve the same given distance. When downshifting, you displace the chain from a smaller sprocket to a larger one and upshifting is the other way around.

D. Choosing the proper gears

When climbing a hill, choose slower gears that are a combination of the smallest chainring with larger rear sprockets. On the other hand, to increase your speed, combine the largest chainring with the smallest rear sprockets. Refer to Figure 22 for visual support.

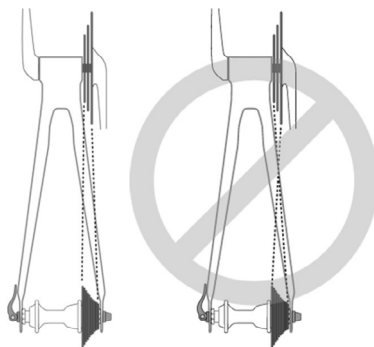

Figure 22

At first, choose a combination of gears that is convenient for you. You should target a gear ratio that allows a decent acceleration without requiring destabilizing effort. Practice gear shifting in a safe place. You should familiarize yourself with the different possible combinations. Once you will have understood these basic principles, you should be ready to shift gears smoothly while riding.

7.5 Tires and inner tubes

7.5.1 Tires

Many tire models are available on the market. There are generic tires for versatility and specific ones that are adapted to particular weather or soil. Devinci has carefully selected tires offering a great quality-to-price ratio to satisfy your specific needs, depending on the biking you do. After a bit of experience, you might want to change your tire types. You could then ask your authorized Devinci dealer for advice.

Your tire size, the recommended pressure and sometimes details concerning the targeted applications are written on the tire sidewall. The most important information concerns the pressure (refer to Figure 23).

⚠ WARNING: Never exceed your tire's recommended pressure, indicated on its side. Exceeding it can result in your tire bursting or going off the rim. This could cause damage to your bike, injury or even death.

The optimal way to inflate a tire is to use a manual pump specially designed for bicycles. Ask your authorized Devinci dealer to assist you in the process of choosing a good pump.

⚠ CAUTION: Inflating compressor units in gas stations have very high airflows that quickly increase the pressure in your tires. When using these kinds of units, inflate your tire carefully with quick bursts to prevent it from being damaged.



Figure 23

As mentioned earlier, your tire sidewall indicates an interval of recommended tire pressure. The maneuverability of your bike on different soils largely depends on your tire pressure.

When inflated to the maximal pressure, your tire offers less resistance and friction. However, this damps impacts. Maximum pressure is recommended on a dry and smooth surface. At the minimum pressure, tires offer better results on smooth or slippery surfaces like compact argyle or light and running soil.

If your tire pressure is insufficient for your weight or riding style, the tire could deform and pinch the inner tube which could result in a tire puncture.

⚠ WARNING: The pressure readings from gas station compressor units are often inaccurate and so are many automotive tire gages. Do not rely on these devices, unless you are confident of their precision. Make sure you always use a quality manometer that provides good and accurate results.

Refer to your authorized Devinci dealer to learn about the tire pressure you should have, according to your riding habits, and inflate your tires accordingly. To check, refer to section 5.4.2. You will then have a visual benchmark to refer to when inspecting your tire pressure. Make sure you check it frequently since it can change quickly.

Some high-end tires have specific direction of rotation. Indeed, their tread is designed to provide a better adherence in a specific direction. In that case, an arrow on the sidewall indicates the proper direction. Make sure the wheels are properly mounted to respect the rotating direction as you go forward.

7.5.2 Valves

Valves allow inflating your tires' inner tubes and keeping their pressure at the same time. Two valve models are available on the market; the

Presta and the Schraeder shown on figures 28 and 29. You need a pump that is compatible with the valve model that your tires are equipped with. Adaptors exist to make the Presta valves fit the Schraeder standard.

The Schraeder valve is the same used by the automotive industry. To inflate a Schraeder valve tube, all you need to do is to unscrew its cap and use a bicycle pump or a compressor. To deflate it partially or completely, just press on the tiny pin in the middle of the valve end with a sharp-pointed object. Always have the valve caps properly hand-tightened before using your bike.

VALVE STEM LOCK NUT

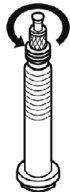

PRESTA VALVE
Figure 24

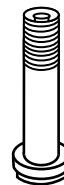

SCHRADER VALVE
Figure 25

The Presta valve has a smaller diameter than the Schraeder and can only be found on bicycle tires. To inflate a Presta valve tube, you need a pump equipped with a Presta head. Remove the cap, unscrew its small retaining nut and press down the small pin to set it free. Insert your pump head on the valve end and just inflate the tube. However, if you wish to inflate a tube using a compressor, you are going to need a Presta adaptor. Ask your authorized Devinci dealer for one. The adaptor can be screwed on the valve end once the small retaining nut is loosened. To diminish the pressure inside your Presta valve tube, unscrew the retaining nut and press it down until you have reached the desired pressure. Tighten the retaining nut and place your cap back before using your bike.

7.6 Toe-clips

Toe-clips are intended to help cyclists maintain their feet in place on their pedals. Furthermore, the toe-clip allows you to adequately position your foot on the pedal, providing the best pedaling power. Cyclists can tighten the straps to maintain their feet on the pedals during the whole pedaling cycle. The main advantage of this mechanism is to allow the use of any kind of shoes, even though results are optimal with adapted shoes. Ask your authorized Devinci dealer for more details.

⚠ WARNING: You need to have specific skills to get on and off a bike that has toe-clips. These skills are earned through practice. Before becoming a reflex, this technique is likely to require all your concentration. Practice using the toe-clips in a safe place where there is no traffic, obstacles or any other risk. Make sure you learn to use them with loose pedal straps and do not tighten them before mastering the technique. Never ride in traffic with tightened straps.

7.7 Clipless pedals

The clipless pedals are used by most experienced cyclists and competitive riders. The pedals offer the advantage of maintaining the feet in the optimal pedaling positioning. Their behavior is similar to those of alpine ski bindings. A rigid plate on the shoe sole gets clamped into the binding. Clipless pedals require specific shoes adapted to the brand and model.

Most models allow for adjusting the clamping and the retaining forces required to operate the pedals. Your authorized Devinci dealer can show you how to do it. Use small clamping forces until you are familiar with the engaging and disengaging techniques.

⚠ WARNING: The clipless pedals bind your foot to the pedal. You need a certain amount of experience to engage and disengage your feet safely from the pedals. Before it becomes a reflex, experience to engage and disengage your feet safely from

the pedals. Before it becomes a reflex, this technique is likely to require all your concentration. Practice using clipless pedals in a safe place where there is no traffic, obstacles or any other risk. Carefully follow the instructions provided with your pedals and seek advice, if necessary, from your authorized Devinci dealer.

7.8 Suspension

All all-terrain bikes have suspension systems. These are designed to help absorb the shocks and impacts encountered while riding off-road. There are many suspension models on the market and to elaborate on each of them would be futile and too exhaustive for this manual. If your bike is equipped with a suspension system, refer to your authorized Devinci dealer for details regarding its maintenance and tuning.

A suspension improves the comfort, stability and maneuverability of your bike. This helps you ride faster on the mountain biking trails. But do not rely only on your bike's superior ability to attack difficult courses. Make sure you also know your own limits. You need to spend lots of time and sweat to increase your riding skills.

⚠ WARNING: If your suspension is maladjusted or poorly maintained, it could malfunction and that could result in a loss of control and a fall.

⚠ CAUTION: By adjusting a suspension, you risk affecting your bike braking and handling capacities. Never try to adjust suspension settings without having previously studied the manufacturer's instructions and recommendations. Test your new setting carefully by doing a short ride in safe spot.

⚠ CAUTION: Your bike is not meant to be equipped with any suspension models. You should check with your authorized Devinci dealer which suspension systems are compatible.

⚠ WARNING: When equipped with a suspension, your bike is likely to become more dangerous at high speeds. Indeed, braking makes the front suspension compress and that could result in loss of control and a fall. You should learn to master the behavior of your suspension before trying to ride on steep terrain and/or at high speeds.

7.9 Component upgrades

There are tons of components out there that are meant to improve your bike's performance, comfort or look. Consult your authorized Devinci dealer in order to receive assistance when choosing new parts.

⚠ WARNING: A bad installation or use of a replacement part could damage your bike and result in loss of control that could cause serious injury or even death.

7.9.1 Comfort improvement

As soon as your bike is well set-up (seat height, positioning and tilt or handlebar adjustments), you can look at some others things that can raise your comfort.

A. Seat

The comfort of a seat is more linked to your morphology than to the thickness of its padding. Devinci has chosen seats that are adequate for most cyclists in your category. However, the seat could be incompatible with your body and feel quite uncomfortable. Your authorized Devinci dealer has many seat models that are likely to suit your needs. If you don't like your seat, consult your authorized Devinci dealer for helping finding better-adapted models.

B. Cycling gloves

If you plan to ride for more than one hour, you should equip yourself with cycling gloves. Their padded palms help prevent the hand numbness caused by the handlebars' vibrations. This feeling, known as carpal tunnel syndrome, can become painful after awhile. Moreover, the gloves will protect you from scratches in case of a fall.

C. Sportswear

In order to improve your comfort and performance, cycling shorts and jerseys are very important accessories. Two types of cycling shorts are available on the market, the loose-fit model and the tight-fit model in Lycra. These are meant to reduce friction and the wear it tends to cause. Make sure you wear them without underpants for optimal comfort as well as to avoid fabric rubbing. Cycling clothes are equipped with back pockets that can carry small objects without having them wobbling as you pedal. Most jerseys are made from special fabrics which help the evacuation of the heat and perspiration and which improve comfort.

D. Hydration

During any physical activity, your body needs to stay hydrated and you should therefore drink a lot of water. The best and simple solution is still the water bottle. When your bike model allows it, it is strongly recommended that you install a bottle holder where it belongs.

7.9.2 Achieving higher performance by upgrading

Most people who want to improve their bike performance start with the drive train and braking component upgrades. But before modifying your bike, you should have your authorized Devinci dealer confirm that the new parts are compatible.

⚠ CAUTION: Your bike warranty may be void after component upgrades. Check with your authorized Devinci dealer that your warranty covers changing parts and components of your bike.

Another way to improve your bike's performance is to upgrade your actual parts (handlebars, stem, wheels, tires, etc.) with lighter ones. You should however remember that lighter parts usually imply a shorter life cycle. Consequently, have frequent inspections to check the condition of the upgraded components.

Important upgrades are the replacement of the front and rear suspension of all-terrain bikes. Before installing a different fork on your bike, have your authorized Devinci dealer check if the frame is designed to accept such changes and the stress associated with them.

⚠ WARNING: Suspension forks, especially double-crown models cherished by downhill riders, tend to induce enormous stresses in the steer tube and front triangle areas. A few bike models are not designed to accept such loads, and sudden frame failure could result, leading to serious injury or even death.

Many all-terrain and hybrid bikes are now equipped with disc brakes. In case your bike has none and you wish to install them, it is recommended you first ask your authorized Devinci dealer to find out if your bike is compatible with disc brakes. Most front suspensions are designed to accept the heavier loads linked to the anchoring points of the disc brake. However, your frame stays might not be intended for such high braking torques. Before installing disc brakes on the rear of your bike, ask your authorized Devinci dealer if your frame can take the increase in stress that comes with it.

⚠ WARNING: Disc brakes induce very high levels of stress in the stays of your bike. If your frame is not designed to tolerate such stresses, it could suddenly fail and cause serious injury or even death.

8.1 Properties of Metals



CARBON AND ALUMINIUM

It is impossible to make generalizations about the metals that are used to make bikes. How the metal is applied is much more important than which type of metal is selected. The way the bike is designed, tested, assembled, and maintained, as well as the characteristics of the metal, are what matters.

Corrosion affects different types of metals in different ways. Steel must be rustproof. Aluminum and titanium are protected from further corrosion by a naturally occurring oxidized film. However, aluminum is not completely resistant to corrosion; when used in conjunction with other metals, care must be taken to avoid galvanic corrosion.

Metals are ductile to varying degrees, which means they can be bent, buckled, and stretched without being broken. In terms of the metals used to make bike frames, steel is the most ductile, while titanium is less so, and aluminum is the least ductile.

The density of metal varies. Density measures the weight of a material in relation to its size. For example, steel weighs 7.8 grams/cm³ (grams per cubic centimeter), titanium 4.5 grams/cm³, aluminum 2.75 grams/cm³. In contrast, the density of carbon fibre composite is 1.45 grams/cm³.

Fatigue has an effect on metals. When metals support high loads, over time, they will begin to develop cracks that may lead to failure. It is crucial that you read and understand [The Basics of Metal Fatigue](#) below.

If you hit a curb, ditch, rock, car, another cyclist or other object at any speed greater than a brisk walk, momentum may carry you over the bike. It would be impossible to stay on the bike, so what happens to the frame, the fork, and other components of the bike itself have no effect on what happens to your body.

What you can expect from your metal frame depends on a number of complex factors. Therefore, crash resistance cannot be a design criterion. An intense impact may cause the frame or fork to bend or buckle. With steel bikes, the forks may bend severely while the frame remains undamaged. Although aluminum is less ductile than steel, the fork and frame are still subject to buckling. The tension associated with more severe impacts may cause the top tube to break, and the down tube to buckle and break, separating the head tube and fork from the main triangle.

Often, bikes frames are metal while the forks are carbon fibre. See [Section B, Understanding Composites](#), below. Since metals are relatively ductile compared to non-ductile carbon fibre, crashes may cause some bending or breaking of metal components while carbon fibre may remain intact. Below a certain load threshold, the carbon fork may be intact even though the frame is damaged. Above a certain threshold, the carbon fork will break completely.

8.2 The Basics of Metal Fatigue

Of course, nothing that is used can last forever. How long something lasts depends on how often and how intensely it is used, and under which conditions. Fatigue is the term used to describe the damage caused by repeated loading. Damage through fatigue occurs when components repeatedly bear loads beyond a certain threshold. A simple example is that, if you bend a metal paper clip back and forth, it eventually breaks. This illustrates that fatigue is not a matter of time or age. A bicycle kept immobile in a garage is unaffected by fatigue, which only occurs through repeated use.

The damage involved occurs when microscopic cracks form in highly stressed areas on a microscopic level. With continued use, the load is applied repeatedly, causing the crack to grow. Eventually, it becomes visible to the naked eye, and will grow so large that the part will be too weak to

support the load that it could carry when it was intact. At that point, the part may immediately and completely fail.

Parts may be designed so that they are strong enough to resist fatigue almost infinitely. This requires using a lot of material and a lot of weight. Any element that needs to be both light and durable will have a finite endurance limit. Aircraft, race cars, and motorcycles all feature components that have a finite fatigue life. A bike with an infinite fatigue life would be far heavier than any bike currently on the market. The trade-off is that a wonderfully lightweight high-performance bike has a finite fatigue life and therefore its structure must be inspected regularly.

⚠ WARNING: Do not ride a bicycle or use a components with any delamination or crack. Riding bikes with delaminated or cracked frames, forks or other components could lead to complete failure, which could cause serious injury or death.

8.3 Understanding Composites

It is essential that all riders must understand a fundamental reality of composites. Composite materials comprising carbon fibers are strong and light, but crashes and excessive loads cause them to break rather than bend.

8.3.1 Composites

Parts that are made out of different components and materials are referred to as composites. Carbon fibre bikes are an example of a composite bike.

Carbon fibre composites are strong, light fibres in a plastic matrix, molded into a certain shape. Carbon composites are lighter than metals. Steel weighs 7.8 grams/cm³ (grams per cubic centimeter), titanium 4.5 grams/cm³, aluminum 2.75 grams/cm³. In contrast, carbon fiber composite weighs 1.45 grams/cm³.

The best strength-to-weight ratios are achieved by carbon fibre in a matrix of epoxy plastic, which bonds the carbon fibres together, transfers the load to other fibres, and provides a smooth outer surface. The carbon fibres themselves form a skeleton-like frame that carries the load.

8.4 The limits of Composites

Well-designed composites or carbon fibre bicycles and components have long fatigue lives which are generally longer than those of their metal equivalents.

Despite the greater endurance of carbon fibre, regular inspection of carbon fibre frames, forks, and components remains necessary.

Carbon fibre composites are not ductile. Once carbon structures are overloaded, they will break rather than bend. Around the breaking point, rough, sharp edges will be found, and delamination of the carbon fibre or fabric layers may occur. There will be no bending, buckling, or stretching.

8.5 Inspection of Composite Frame, Fork, and Components

A. Cracks

Inspect for cracks, or broken, or splintered areas. All cracks are serious. If a crack of any size is found, do not ride the bicycle.

B. Delamination

Delamination indicates serious damage. Composites are made from layers of fabric. Delamination means that the layers of fabric are no longer bonded together. If any sign of delamination is found, do not ride the bicycle or use the component. Signs of delamination include:

- A translucent or white area. This looks different from ordinary undamaged areas. Undamaged areas will appear glossy or shiny. Delaminated areas will look opaque and foggy.
- Bulging or deformed shape. If delamination occurs, the surface shape may change. The surface may have a bump, a bulge, a soft spot, or not be smooth.
- A difference in sound when tapping the surface. If the surface of an undamaged composite is gently tapped, it will produce a consistent sound, normally hard and sharp. In comparison, tapping a delaminated area will generally produce a duller, less sharp tone.

C. Unusual Noises

Cracks and delamination may cause creaking noises while riding. Think about such a noise as a serious warning sign. A well maintained bicycle will be silent and free of creaks and squeaks. If any noises are detected, they must be investigated so that the source is found. It may not be a crack or delamination, but whatever is causing the noise must be repaired before riding.

⚠ WARNING: Do not ride a bicycle or component with any delamination or crack. Riding a delaminated or cracked frame, fork or other component could lead to complete failure, and may cause serious injury or death.



MAINTENANCE AND REPAIR

Notice: New technologies now allow the modern bike to become highly efficient but very complex at the same time. This complexity, along with a high number of recent innovations, make it impossible for us to provide you with all the necessary information you would need to maintain and repair your bike. In order to minimize the risk of accidents and injuries, we strongly recommend you bring your bike to your authorized Devinci dealer for maintenance and service.

Your authorized Devinci dealer is certainly the best resource to get your bike tuned-up or fixed. Indeed, the maintenance that you can perform yourself depends largely on your skills, your experience and the tools you have at your disposal.

The maintenance required for your bike is determined by many factors, ranging from your cycling style to your geographical location. Consult your authorized Devinci dealer to identify your maintenance needs.

⚠ WARNING: Many situations you may encounter require very specific knowledge and tools. Do not attempt to tune or fix your bike if you doubt in any way your ability to finish it. Any error could lead to bike damage and serious injury or even death.

If you wish to learn to repair your bike by yourself, three possibilities lay ahead of you:

- *Ask your authorized Devinci dealer to suggest books that cover bike repair and maintenance;*
- *Ask your authorized Devinci dealer to provide you with the manuals of installation and maintenance of the various components your bike is equipped with;*

- *Ask your authorized Devinci dealer to inform you concerning bike mechanics classes and training near you.*

No matter what your choice ends up being, we advise you to ask your authorized Devinci dealer to inspect the quality of your work before using your bike. This precaution is meant to ensure that everything is correct and properly functioning. Since this check-up is time-consuming, it is likely that your authorized Devinci dealer will charge a small monetary compensation.

9.1 Maintenance Schedule

Some maintenance operations as well as some repairs have to be executed by the owner of the bicycle and do not require any particular tools or specific skills. Here is the list of the maintenance operations and repairs that you should do yourself. Any other repairs or maintenance have to be done in a proper local with a certified mechanic with the necessary tools at their disposal.

9.1.1 Breaking-in period

The durability of your bike as well as its functioning will be improved if you take the time to do a break-in phase before putting it under severe stress. The shifters, the brake cables and the spokes are likely to elongate or contract during the first rides. You might also need to get them adjusted after a few runs. When doing your safety mechanical inspection from section 5.4, you could find out that a few elements need to be readjusted. However, even if every element seems in order, it is preferable to bring the bike need to be readjusted. However, even if every element seems in order, it is preferable to bring the bike back to your authorized Devinci dealer for a check-up. Usually, the authorized Devinci dealer advises bringing your bike back to them after 30 days or after riding 5 hours on all-terrain or 15 hours on road, whichever comes first. They will then proceed to the first maintenance. Nevertheless, if you noticed any anomalies before this, you would need to bring your bike to your authorized Devinci dealer before using it again.

9.1.2 Before every use

Proceed through the safety mechanical inspection as shown in section 5.4.

9.1.3 After every long or intense ride

If your bike goes through water, mud and dust, or after many kilometers traveled, you should clean up your bike carefully. Lubricate the chain, the front and the rear derailleur, the cassette and the chainrings without getting the brakes, the discs, the wheels and the rims exposed. Sweep lubricant excess. Refer to your authorized Devinci dealer to learn what lubricant to use and when to do it, depending on your geographical location.

9.1.4 After every long or intense ride or after 10 to 20 hours of use

- *Block your front wheel firmly with your brake and swing the bike back and forth to get a feeling for different articulations. If you hear a cracking noise or if you feel something loose, then the stem could have loosened. Have your authorized Devinci dealer run a check-up;*
- *Lift the front wheel and turn it from side to side. Does it feel smooth or hard? If you feel too much restriction, your stem could be excessively tightened. Have your authorized Devinci dealer run a check-up;*
- *Take a pedal and pull and push several times. Repeat with the other pedal. Do they feel loose? If they do, have your authorized Devinci dealer run a check-up;*
- *Check your brake pads, are they worn or not positioned properly on the rim? If so, have your authorized Devinci dealer run a check-up;*

- *Make sure your cables and sheaths are in order. Can you see rust, strain or wear on the cables? If so, have your authorized Devinci dealer run a check-up;*
- *Press each pair of spokes that are facing each other between your thumb and your forefinger. Are they tightened enough? If not, have your authorized Devinci dealer run a check-up;*
- *Run a complete inspection of your frame by looking for cracks, deep scratches or discoloration. Carefully check the welds, the junctions of the tubes, the head tube area and the bottom bracket area. If you find something suspicious, have your authorized Devinci dealer run a check-up;*
- *Check that every component and accessory is securely attached and that there's no looseness. Tighten them back if necessary or ask your authorized Devinci dealer for assistance.*

⚠ WARNING: A bike and its components sustain the high levels of repetitive stresses. The fatigue endurance depends largely on the nature of the materials and their micrographic structures. If you use a component longer than its standard fatigue life, it risks cracking and then suddenly breaking, causing serious injury or even death. The appearance of cracks, scratches or discolorations are clues that your bike is fatigued and worn. If you find any of these, immediately ask your authorized Devinci dealer to evaluate the components and replace them if necessary.

9.1.5 Braking and shifting issues

If you find a problem with your brakes when doing your safety mechanical inspection, try adjusting their strokes by turning their tuning barrel. Make sure you lock it back screwing its lock nut. If the problem persists, ask your authorized Devinci dealer for assistance.

If you find a shifting problem when doing your safety mechanical inspection, the derailleur is probably maladjusted. The problem may come from a simple elongation of your shifter cable.

Turn the shifter's tuning barrel counterclockwise a quarter of a turn and lock it back with its lock nut. If the problem persists, ask your authorized Devinci dealer for assistance.

9.1.6 After riding 25 off-road hours or 50 road hours

Bring your bike to your authorized Devinci dealer for a complete check-up.

9.2 Emergency repair

If you ride your bike near your home and a mechanical failure occurs, you could still get back on foot or call a friend to pick you up. However, the situation is not the same if you're on a long ride. Here's why it is essential you bring the following equipment in case of emergency:

- *Allen keys (4mm, 5mm and 6mm) to tighten your bike screws;*
- *A small tire pump or an inflating cartridge compatible with your valve;*
- *Spare tire tube;*
- *Tire removing tool;*
- *Your identity cards;*
- *Cash to quench your thirst, buy foods or use a phone.*

9.2.1 Flat tire

Remove the wheel as shown in section 7.1.1. Press the valve to empty the inner tube completely, referring to section 7.5.2. Start removing the tire from the rim, on the end opposite to the valve. To do so, press simultaneously on the tire from the interior of the rim and lift the tire by sliding it on the rim or use a tire removing tool to gently lift the edge of the tire over the rim.

Remove the valve lock nut and push the valve through the rim. You can now remove the inner tube.

Inspect the tire carefully to identify and remove, if possible, the object that caused the flat. If the tire is cut, try covering the damaged area to prevent pinching the inner tube.

Use tape, a spare patch, a piece of the old inner tube, a piece of paper or anything similar that could temporarily do.

Install a patch on the inner tube as shown in the patch installation manual or even better, change the inner tube for a new one.

⚠ WARNING: The installation of a patch on your tire's inner tube is an emergency and temporary repair. The use of a patch may weaken the tire considerably and cause a puncture that could result in loss of control and a fall. Replace the patched tube with a new one as soon as possible.

Place the inner tube inside the tire and place the tube valve in the rim hole. Do not tighten the nut yet. Inflate the tube slightly and insert the tire on the rim with your thumbs, starting at the valve. Avoid pinching the tube between the rim and the tire. If you are not able to insert the last few centimeters of tire, use a tire removing tool very carefully, trying not to pinch the tube.

⚠ WARNING: You risk piercing the tube if you try installing your tire with a screwdriver or any other tool not intended for this use.

Check with your hands that the tire is properly centered with respect to the rim and that the tube is well-positioned. Inflate the tube to the recommended pressure by referring to section 5.4.2.

Tighten the valve lock nut with your hands and install your wheel back on your bike.

⚠ WARNING: Never ride with a flat or deflated tire. You risk damaging the tire, the wheel and the bike, and could also lose control and fall.

9.2.2 Broken spoke

When one of your wheel's spokes becomes broken or loosened, your wheel is weakened. If you break a spoke during a ride, get back to your starting point really slowly and safely since you risk breaking others and irreversibly damaging the wheel.

⚠ WARNING: A broken spoke weakens the wheel considerably. This could make it wobble and rub against the brake pads or the frame. You would therefore risk losing control and falling.

When you have a broken spoke, twist it around its closest neighbor in order to avoid jamming between the wheel and the frame. Lift the wheel and turn it to make sure it turns safely and that the wheel does not touch the brake pads. If the wheel touches the brake pads, then you need to walk

your bike to your starting point. It is very dangerous to ride with a wobbling wheel that has a broken spoke. Have your authorized Devinci dealer repair or change your wheel as soon as possible.

9.2.3 Accident or major impact

First make sure you are not seriously hurt.

⚠ WARNING: An accident may prematurely wear the different parts of your bike, therefore causing unexpected failures that could cause injury or even death.

After an accident, inspect your bike carefully and repair everything that you can. Do not hesitate to contact your authorized Devinci dealer for assistance in the process. Once back at your starting point, proceed to the detailed mechanical check-up described in section 5.4 in order to identify every damaged part. Replace every part which has been bended, deeply scratched or discolored.

⚠ CAUTION: Bring your bike to your authorized Devinci dealer after an accident or a serious fall for a complete inspection.

Carbon fiber has been put to the test in recent years and has yielded excellent results. It has very different properties than aluminum. Unlike aluminum, carbon fiber is not subject to fatigue, does not deform, does not bend or dent: it breaks. Damaged carbon fiber components may not appear compromised or dangerous but can be subject to sudden failure as result of impact, and may do so without warning. DEVINCI would like you to enjoy safe rides. If you crash or your bicycle has suffered a major impact, have an authorized DEVINCI dealer inspect your bicycle.

⚠ WARNING : A damaged carbon fiber frame may fail under impact and cause an accident leading to serious injury or even death. A crash or impact may result in damaged carbon fiber. If you suspect damage to your carbon fiber frame or components due to crash or impact, bring your bicycle immediately to an authorized DEVINCI dealer for inspection. DO NOT CONTINUE TO RIDE!



MATERIAL KNOWLEDGE, ALUMINIUM AND CARBON

10.1 Inspection

Inspect regularly your frame and components using your eyes, ears and hands. If you suspect an anomaly, cease riding immediately and bring it to an authorized DEVINCI dealer for inspection.

10.1.1 Visual

Visually inspect your carbon fiber frame and components. Checks for deep scratches, cracks, bumps or any other surface damage.

10.1.2 Touch

Be attentive to any change in performance or comfort during riding. Abnormal vibration, sudden loss of braking power or pedaling resistance can be signs of a problem.

10.1.3 Auditory

Be attentive to any abnormal noise. Cracking, grinding or any other abnormal noise may be indicative of a problem.

10.2 Maintenance

Carbon fiber requires more careful and frequent maintenance than other materials. Devinci recommends to:

- *Clean your carbon fiber components after each use to remove any abrasive elements such as sand, small pebbles, tar or any other road contaminants;*
- *Use a clean 100% cotton rag. Be sure that no abrasives stay stuck to the rag you are using to wipe the carbon fiber;*
- *Use a mild non-abrasive detergent;*
- *Do not use a high pressure water jet directly on your carbon fiber.*

⚠ WARNING : Improper maintenance or negligence could lead to damage. A damaged carbon fiber component may fail under impact and cause an accident leading to serious injury or even death. Improper maintenance could void your warranty.

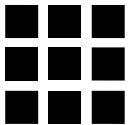

STORAGE YOUR BICYCLE PROPERLY

11.1 Proper Use

It is very important how you place a carbon fiber bicycle or aluminium bicycle on a repair stand, on a car rack, in a bicycle travel case or just simply in storage.

11.1.1 Bicycle racks

The only bicycle racks authorized by DEVINCI are those that do not come into direct contact with any carbon fiber. Conventional trailer hitch racks and vertical frame type supports are not recommended.



11.1.2 Repair stands

Never place a bicycle on a repair stand where the jaws clamp on the carbon fiber frame or seat post. Doing so could permanently damage the carbon fiber tubes. Substitute an aluminum seat post or use our DEVINCI adaptor for aero seat post (MASA08001).



11.1.3 Bicycle travel case

If your bicycle travel case requires that you remove the wheels, it is imperative that you place spacers between the rear drop outs and the front fork drop outs to prevent misalignment of your frame. Make sure that no loose items in your travel case come into direct contact with your carbon fiber frame or components.



11.1.3 Storage

It is important to store your carbon fiber frame following these guidelines:

- *Always clean and maintain your bicycle before storing;*
- *Always store your bicycle in the following environment: indoors, a dry place, away from sunlight and damaging UV rays, away from dust, above freezing;*
- *Store your bicycle in a normal upright and vertical position and do not place any load on it;*
- *Be sure that nothing rubs up against the frame or is leaning against it.*

⚠ WARNING : Improper use of carbon fiber frame and components can lead to damage. A damaged carbon fiber frame may fail under impact and cause an accident leading to serious injury or even death. Improper use of carbon fiber components can void the warranty.

11.2 Frame replacement policy

DEVINCI offers the first owner of a carbon fiber DEVINCI frame a replacement price for any accidental damage incurred to the frame. Consult your local DEVINCI retailer for more information on our crash replacement policy.



DEVINCI'S RIDE IN PEACE WARRANTY

WARRANTY PERIOD FROM DEVINCI CYCLES INC.

The frames of cycles devinci inc. 1555 Manic, Chicoutimi, Québec, Canada ("Devinci") are guaranteed against all manufacturing defects, for the periods specified below, as of the date of the initial purchase. During there specific periods, Devinci will replace or repair without charge, and at its discretion, the Devinci frames that display a manufacturing defect. The parts replaced or repaired in according with this warranty will be covered for a period equal to the remaining portion of the warranty of the original equipment. All frames are quaranteed for life. Paint and decals placed under Devinci clear coat on all frame models : 1 year.

The pivot * for full suspension frames : 1 year

The components assembled on Devinci frames are guaranteed by their respective manufacturers. Please contact your authorized Devinci retailer for more information regarding the applicable warranty.

*The pivots include the bearings, bolts and axles holding together the elements of the suspension of the rear triangle.

WARRANTY EXCLUSIONS

Each Devinci bicycle was conceived for a specific use. The operational life of a bicycle varies according to its construction, maintenance and the care provided. Intensive use, use with a heavy load, use during competitions or for activities other than those for which the bicycle was conceived decreases largely its operational life. Any of these conditions may lead to a random failure. Abusive use will therefore cancel the warranty. Vinyl decals placed over the Devinci clear coat are not covered by warranty.

THIS WARRANTY DOES NOT COVER:

- *Regular maintenance (Cleaning, Lubrification or inspection);*
- *Transport or shipping charges incurred as a result of the execution of the warranty;*
- *Cost of labour related to the assembly, disassembly, repair of replacement parts;*
- *Damages caused by normal wear and tear including damages caused by material fatigue.;*

THIS WARRANTY DOES NOT APPLY IF:

- *The damages were caused by a fortuitous event;*
- *The bicycle was purchased from a retailer other than those authorized by Devinci;*
- *The bicycle was not entirely assembled by an authorized Devinci retailer;*
- *The bicycle was repaired by a person other than an authorized Devinci retailer;*
- *You are not the original owner of the bicycle;*
- *The instructions contained in the user's manual for all frames and the technical manual for frames with full suspension were not respected;*
- *The periodic inspection recommended in the user's manual for all frames was not carried out;*
- *Parts not supplied by Devinci with the bicycle or not indicated in the user's manual for all frames or the technical manual for the frames with full suspension were used;*
- *The bicycle was used for an activity other than those for which it was conceived;*

- *The bicycle and/or its components were subject to abusive use, negligence, abnormal and/or excessive use or was implicated in an accident;*
- *The frame is too small for you;*
- *You used another seatpost than the one sold with your bike;*
- *The frame and/or its components were modified (ex: polishing, structural or mechanical modification or addition, tripping, sanding, strain hardening, shot peening);*
- *You continued to use your bicycle while it was damaged.*
- *Transport or shipping charges incurred as a result of the execution of the warranty;*
- *Cost of labour related to the assembly, disassembly, repair of replacement parts;*
- *Damages caused by normal wear and tear including damages caused by material fatigue;*

EXCHANGE POLICY IN CASE OF ACCIDENT

Devinci is aware that the purchase of a high performance bicycle is done with the heart. This is why our customer service applies an exchange policy at a low price to accommodate claims that would have been refused for one of the reasons mentioned in the section 'warranty exclusions'. This policy applies only to the initial buyer. Please contact your Devinci retailer for more information.

Limitation of liability: This is an integral warranty, complete and final, for Devinci frames. Devinci does not give authorization to any other person, including the authorized Devinci retailers, to assume or grant, expressly or implicitly, any or other person(s) and any demonstration or illustration of Devinci frames is in no way linked to Devinci and is furthermore excluded from this warranty.

Devinci assumes no liability in case of any property damage, moral or bodily injury to the user, the buyer or any other person(s), resulting from the use of a Devinci frame or one of its components.

Except as limited or expressly forbidden by law, regarding any other condition or guarantee, express or implied, based in law, established commercial customs and usage, including but not limited to, guarantee of merchantability or adaptation to a specific end, Devinci declines any responsibility for any amount exceeding the actual purchase price or the bicycle nor for any particular, accessory or consecutive damages that may occur in connection with said bicycle.

With regard to the exercising of rights resulting from the present warranty, the buyer of a devinci frame agrees to elect domicile in the judicial district of Chicoutimi, in the province of Québec, Canada, as an appropriate place for the hearing of all claims or legal proceedings.

DEVINCI Cycles Devinci Inc.

1555 MANIC STREET, CHICOUTIMI (QUEBEC) CANADA G7K 2G8

PHONE : (418) 549-6218 FAX: (418) 549-3991

WWW.DEVINCI.CA